

COMMUNICATIONS RECEIVER

MODEL SP-600-VLFS1

INSTRUCTIONS

MANUFACTURED BY

THE HAMMARLUND MFG. CO INC.

55 WEST 23rd STREET

NEW YORK 10, NEW YORK, U.S.A.

Manual provided by John L. Kolb

Scan by Jeffrey L. Adams

eengineer@erols.com

Not For Commercial Use

C O M M U N I C A T I O N S   R E C E I V E R

M O D E L   SP-600-VLF31

I N S T R U C T I O N S

M A N U F A C T U R E D   B Y

T H E   H A M M A R L U N D   M F G.   C O.   I N C.

53 WEST 23rd STREET

NEW YORK 10, NEW YORK, U.S.A.

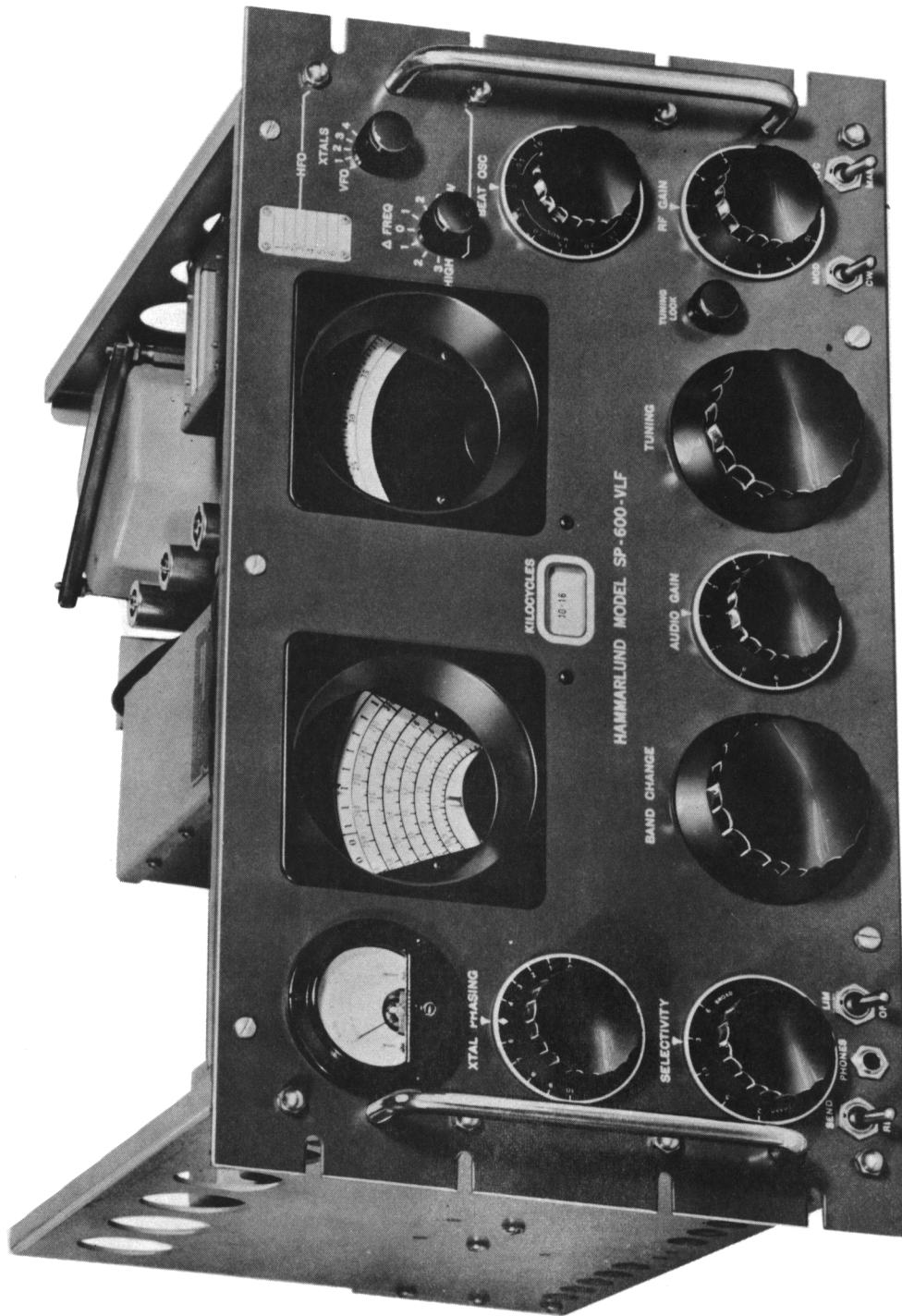

FIG. 1  
FRONT VIEW OF RECEIVER

## TABLE OF CONTENTS

Title	Page
Technical Summary.....	4
I General Description.....	6
II Circuit Description.....	9
III Installation.....	11
IV Operation.....	13
V Maintenance.....	17
VI Alignment.....	23
Table 1 - Tube Socket Voltages.....	21
Table 2 - Tube Socket Terminal Resistances.....	22
Table 3 - RF and HF Oscillator Alignment Frequencies.....	25
Table 4 - Approx. Signal Inputs at IF and AF Stages.....	25
Table 5 - Parts List.....	28

## ILLUSTRATIONS

Figure 1 Front View of Receiver.....	2
Figure 2 Block Diagram.....	8
Figure 3 Location of Tubes and Adjustments.....	26
Figure 4 Selectivity Curves.....	27
Figure 5 Rear View of Receiver.....	35
Figure 6 Top View of Receiver.....	36
Figure 7 Top View of Receiver - Capacitor Shield Removed.....	37
Figure 8 Bottom View of Receiver - Tuning Shield Removed.....	38
Figure 9 Bottom View of Receiver.....	39
Figure 10 Circuit Diagram of Receiver.....	40

# COMMUNICATIONS RECEIVER

## MODEL SP-600-VLF 31

### TECHNICAL SUMMARY

#### Electrical Characteristics

Frequency Range - total 6 bands.....	10-540 kc
Band 1.....	10-16 kc
Band 2.....	16-28 kc
Band 3.....	28-50 kc
Band 4.....	50-100 kc
Band 5.....	100-217 kc
Band 6.....	217-540 kc

Power Output - 2.0 watts, with less than 10 percent distortion.

Output Impedance - 600 ohms balanced split windings.

Phone jack winding; delivers 15 milliwatts to an 8000-ohm resistive load, when the audio output to the 600-ohm power load is adjusted to 500 milliwatts.

#### Power Supply Requirements

Line Rating.....95, 105, 130, 190, 210, 234 and 260 volts 50-60 cycles.

Power Consumption.....130 watts, 1.25 amps. at 117 volts-maximum.

#### Tube Complement - total 21

RF, IF and BFO.....	8-6BA6
HF and 2nd Conversion Oscillators.....	2-6C4
Controlled HF Oscillator.....	1-6AH6
Mixers.....	2-6BE6
Detector, "C" Bias Rectifier and Noise Limiter and Meter Rectifier.....	3-6AL5
AF Amplifier and IF Output.....	1-12AU7
Power Output.....	1-6V6GT
Rectifier.....	1-5R4GY
Voltage Regulator.....	1-0A2
Voltage Regulator.....	1-0B2

#### Mechanical Specifications

Rack Model -- Dimensions; 19 inches wide,  $10\frac{1}{2}$  inches high and  $16\frac{1}{2}$  inches deep from rack mounting surface. Weight 70 lbs.

Table Model -- Dimensions;  $21\frac{3}{8}$  inches wide,  $12\frac{3}{4}$  inches high and  $17\frac{1}{8}$  inches deep. Weight  $87\frac{1}{2}$  lbs.

Performance Data-- (approximate values - taken on a sample receiver).

Selectivity at 3kc

Sensitivity is 3.5 microvolts, or better throughout the entire frequency range, for a signal to noise ratio of 10 db, at 20 milliwatts output and with RF Gain Control at maximum. Image rejection ratios are better than 74 db throughout the frequency range.

The IF rejection 60 db or greater.

The AVC action will maintain the output constant within 14 db when the input is increased from 5 to 200,000 microvolts.

The 455 kc IF output is approximately 100 millivolts in a 72-ohm load at normal input signals.

## GENERAL DESCRIPTION

Since this receiver covers a unique frequency range, extending to audio frequency "10 KC", the normal concepts of operation of superheterodyne receivers will not hold. It is important therefore, that the operating instructions in Section IV be followed to obtain proper performance.

The SP-600 VLF is a 21 tube Radio Communications Receiver with self contained power supply. This receiver is made using components having characteristics which are the equivalent of military component specifications insofar as is practicable.

The receiver is supplied in either a well ventilated steel, table model cabinet finished in dark grey to complement the lighter grey front panel or for mounting in a standard 19 inch relay rack.

The self contained paper supply is designed for operation from a single phase, 50 to 60 cycle alternating current power source. The power transformer primary is provided with taps covering a line voltage range from 90 to 270 volts. The power consumption is 130 watts.

The receiver is suitable for either headphone or loudspeaker reception of AM radio telephone, CW telegraph, AM MCW telegraph signals and for carrier-shift radio teletype signals.

The standard model provides continuous coverage over a frequency range from 10 to 540 kilocycles in six bands. The large easily operated band change control knob, on the front panel, selects the desired frequency band and a band indicator visible through a small front panel window indicates the frequency band in use. This control also aligns the dial frequency indicator with the proper dial scale.

In addition to the frequency scales, the main dial has an arbitrary scale which, in conjunction with the vernier dial provides continuous expanded scales over each frequency band for extremely accurate logging and resetability.

The single tuning control is large and of special design to permit maximum traverse speed as well as exceptional operating ease. It controls both the main and vernier dials. An anti-backlash gear train provides extremely close calibration accuracy and completely accurate resetability. A tuning lock provides positive locking action without affecting the frequency setting.

The tuning ratio from the tuning control to the main dial is 50 to 1 and the ratio from the vernier dial to the main dial is 6 to 1.

Two stages of radio frequency amplification are provided on all bands. Four stages of IF amplification, detector and AVC rectifier noise limiter and meter rectifier, beat frequency oscillator, IF output, AF amplifier and output power stage are provided.

The frequency control unit provides for crystal controlled operation on any four frequencies within the range of the receiver. Front panel controls permit the selection of the normal high stability, continuously variable tuning or either of the four selected fixed frequency signals. For crystal controlled fixed channel operation it is only necessary to set the dial to the signal fre-

quency, switch to the crystal frequency desired and tune with the delta frequency control. These crystals are not supplied with the receiver, but may be purchased on special order from HAMMARLUND MFG. COMPANY specifying the signal and oscillator frequency for which each is to function.

The noise limiter circuit effectively limits the interference from ignition systems or other sources of pulse type noise. The limiter switch permits optional use of the limiter.

The antenna input circuit is designed for use with a balanced line. The input impedance is nominally 72 ohms. The receiver may also be operated with a conventional single wire antenna.

The audio output circuit is designed for a 600-ohm load or line and is provided with a four terminal split winding for balanced load operation. Maximum power output is approximately 2.0 watts. The headphone circuit when referred to an 8000-ohm load provides signals attenuated approximately to 15 db below the 600-ohm power output.

The send-receive switch desensitizes the receiver but leaves the power on for instant reception between transmission periods.

Radiation is negligible and complies with requirements for shipboard operation and for multi-receiver installations.

Dial frequency drift after a 15 minute warm up period ranges between .05 percent and 1.0 percent of frequency depending on the frequency used. This is equivalent to .01 to .02 percent HF osc drift and very unusual degree of frequency stability for variable tuned HF oscillators and closely approaches crystal stability.



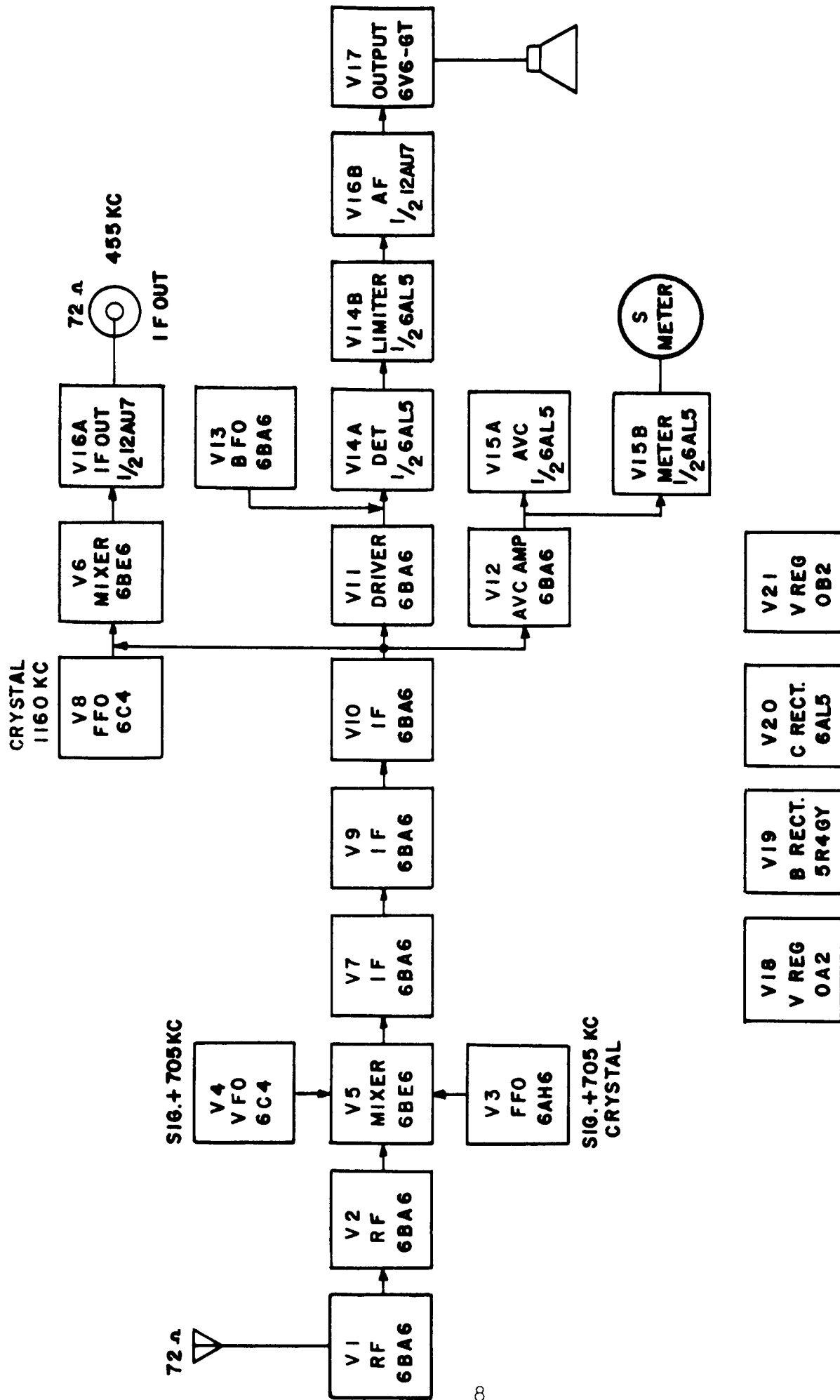

BLOCK DIAGRAM  
FIG. 2

## II

### CIRCUIT DESCRIPTION

General - The circuit is shown schematically in Figure 10. A block diagram, Figure 2, is provided to more clearly show the arrangement and functions of the various circuit sections. The location of the various tubes is shown in Figure 3. The circuit consists of two stages of RF amplification V-1 and V-2, First Mixer V-5, First Heterodyne Oscillator V-4, four stages of IF amplification V-7, V-9, V-10 and V-11, Detector and Limiter rectifier V-14, Meter and AVC rectifier, V-15, Beat Frequency Oscillator V-13, IF output and AF amplifier V-16-A and V-16-B, Output Power stage V-17 and the Power Supply system which includes B Power Rectifier V-19, C Bias Rectifier V-20 and Voltage Regulators V-18 and V-21.

Input Coupling - The antenna coupling is designed to provide optimum coupling from a 72-ohm transmission line. A balanced or straight wire antenna may be used.

RF Amplifier - An ingeniously designed rotary turret is employed to change bands and to place the coil assemblies of the RF amplifier V-1, and V-2, Mixer V-5 and First Heterodyne Oscillator V-4 stages directly adjacent to their respective sections of the four gang tuning capacitor and their respective tubes. This assures maximum sensitivity at high signal-to-noise ratio.

First Heterodyne Oscillator - (Variable V-4) - The rotary turret band change switch, advanced design of the four gang, twin section variable tuning capacitor and rugged construction throughout, provide frequency stability and dial calibration accuracy to a previously unattained degree.

First Heterodyne Oscillator - (Crystal Controlled V-3) - For services requiring extremely stable, fixed frequency operation, a crystal controlled high frequency oscillator is provided. Instant changeover from variable to crystal controlled oscillator with a choice of four crystal positions, is effected by a front panel control. A second front panel control permits adjustment of the crystal oscillator frequency over a plus or minus .005 percent range.

Intermediate Frequency Amplifier - There are four stages of IF amplification incorporating the Hammarlund patented crystal filter circuit. Five positions of selectivity provide 6 db bandwidths of .2, .5, 1.3, 3 and 6 kc. The crystal phasing control provides for the high attenuation of closely adjacent interfering signals, on the .2, .5 and 1.3 kc selectivity positions.

The signal is heterodyned to 705 kc by the first Mixer V-5 and Oscillator V-4 or V-3. The 705 kc signal is later heterodyned to 455 kc by the Second Mixer V-6 and the 1160 kc Fixed Crystal Controlled Oscillator V-8 to provide 455 kc IF output.

Detector and Limiter - The V-14 tube is used as high level Detector and Limiter. The noise limiter circuit limits the noise interference from ignition systems or other sources of pulse type noise. A separate control switch, S-6, permits optional use of the limiter on any mode of operation when pulse type interference is present.

Beat Frequency Oscillator - The beat frequency oscillator employs a high capacity Colpitts circuit which gives a high order of frequency stability and minimizes oscillator harmonics. The beat frequency Oscillator, V-13, is electron-coupled into the detector circuit, eliminating oscillator lock-in. A front panel control varies the audio beat frequency from zero beat to plus or minus 3 kc.

AVC and Tuning Meter - The V15 tube is used as AVC and Meter rectifier. The AVC circuit is provided with separate time constants for CW and MCW operation. AVC and Diode output terminals provide for connections in diversity applications. The tuning meter is used on AVC operation to indicate the accuracy of tuning and the relative strength of received signals.

Audio Output - The audio output tube V-17, is transformer-coupled through a split, balanced winding to deliver 2.0 watts undistorted output to a 600-ohm load. The split balanced winding permits balancing of the direct current in the output circuit as used for teletype or similar service. A separate secondary winding provides attenuated audio signal output for headphone operation. This winding will deliver an output of 15 milliwatts into an 8000-ohm resistive load when the 600-ohm power secondary is delivering 500 milliwatts to a 600-ohm resistive load.

IF Output -- A cathode follower V-16-A provides a 70-ohm impedance source of intermediate frequency (455 kc) to socket, SO-239, on the rear skirt of the chassis. A PL-259 plug and RG-11/U cable, not supplied, are used for this connection.

Power Supply -- The power supply is an integral part of the receiver. It includes the B rectifier V-19 and the C rectifier V-20, together with their respective low pass filters and the Voltage Regulators V-18 and the V21. The power transformer is provided with screw terminal primary taps, covering a power line source range of 90 to 270 volts, 50 to 60 cycles. The power transformer and filter components are protected by fuses in the primary and plate supply circuits.

RF Gain Control and Power Switch -- The RF gain control is provided for manual control of sensitivity to prevent overloading on strong signals when operating with the AVC-MANUAL switch in the "MANUAL" position. This control also operates when the switch is in the "AVC" position. The Power "ON-OFF" switch is operated at the counter clockwise extremity of the RF gain control.

Send-Receive Switch -- The send-receive switch desensitizes the receiver but leaves the power "on" to provide for instant reception between transmission periods.

Radiation -- Advanced design and shielding of the high frequency, second conversion crystal and beat frequency oscillators has reduced radiation to a negligible point so that interference of this nature, common in multi-receiver installations, is reduced to a minimum.

### III

#### INSTALLATION

Tubes and Packing -- After unpacking the receiver see that all tubes are firmly in their sockets and that all packing material is removed from the receiver.

Power Supply -- Make sure that the primary tap lead at the bottom of the power transformer is connected to the tap which most nearly agrees with the 50 to 60 cycle power source voltage.

Antenna -- The input impedance at the antenna socket, UG-103/U, is designed to match a 72-ohm transmission line. The angle plug adapter, UG-104/U, and connector plug, UG-102/U, supplied with the receiver, are designed for RG-22/U cable which should be used with a balanced antenna installation. Screw terminals are also provided for antenna connections. If it is desired to operate with a single wire antenna, the antenna lead-in wire should be connected to one antenna terminal and a ground lead should be connected from the other antenna terminal to the ground terminal, which is adjacent to the antenna socket at the rear of the receiver.

Speaker -- The speaker should be of the permanent magnet dynamic type and should include a speaker voice coil to 600-ohm line matching transformer for connection to the 600-ohm audio output terminals of the receiver. Caution: When the 600-ohm output is not used, connect a 600-ohm, 2 watt resistor to these terminals to avoid component damage from high transient peak voltages. For applications requiring the insertion of direct current control or indicating voltages, the jumper connecting the two balanced sections of the 600-ohm output may be removed and the insertion circuit, such as a low resistance balancing potentiometer, connected in its place.

Headphones -- Either high or low impedance headphones may be used by plug connection to the phone jack, located at the lower left side of the front panel. The high impedance type is recommended.

Mounting -- The receiver is designed for either table or rack mounting. Table models are supplied in a well ventilated steel cabinet with handles and protective rubber feet. Rack models, with top and bottom cover plates are supplied for mounting in a standard 19 inch rack. The panel is 10½ inches high. The receiver should be placed in a position which permits the free access of air.

Crystals for Frequency Control -- Crystals, Y1 to Y4, are not supplied with the receiver, but will be supplied on special order for any signal frequency in the range of the receiver. Crystal units may be ordered from HAMMARLUND MFG. CO., INC. In order to insure correct crystal controlled frequency operation the order should specify the signal frequency for which each unit is to be used. (See note at end of Table 5.) Mark the signal frequency for which each crystal was selected, in megacycles on the plastic chart provided for this purpose alongside the crystal switch, S2. Pencil or ink may be used and can be erased if it is desired to change these figures at any time. The numerals on the chart should be used so that they agree with the numerals on the crystal socket positions, which are also indicated by the crystal selector switch.

Relay Connections -- If external relay operation for the send-receive function is desired, connection may be made by soldering a twin conductor cable to the terminals of the Send-Receive switch, S5. In this case S5 is left in the

Send or open position.

AVC and Diode Output -- Shunt connection to the AVC bus and series connection to the detector diode load are provided at the rear of the receiver for diversity applications. The Diode Output terminals are provided with a wire jumper connection when these terminals are not used for external connection.

IF Output -- The IF Output socket, SO-239, at the rear of the chassis provides for connection in diversity, teletype or other applications where a source of 455 kc, intermediate frequency is required. A PL-259 plug and RG-11/U cable should be used. This will provide an output of approximately 100 millivolts to a 70-ohm resistive load, with a normal sensitivity input of 2.5 microvolts signal.

## IV

### OPERATION

General -- Before attempting operation of the SP-600 receiver, the operator should familiarize himself thoroughly with the functions and uses of the various controls. When referring to the controls in this description, the words in capital letters represent the part of the name adjacent to the control on the front panel or on the rear skirt of the chassis. For example, when referring to the SELECTIVITY control, the word SELECTIVITY in capitals indicates the legend appearing adjacent to the control. Reference to photographs, Figs. 1 and 5, is suggested while reading this description. Front panel controls and dials are shown in Fig. 1 and rear controls and terminals are shown in Fig. 5.

Selectivity Control -- The SELECTIVITY control is a 5-position switch which selects degrees of selectivity, ranging from extremely sharp for cw reception to broad for good fidelity mcw operation. The SELECTIVITY control dial indicates the 6 db bandwidth at each setting. DO NOT USE 6 KC SELECTIVITY FOR 10 to 28 KC SIGNALS.

Phasing Control -- The CRYSTAL PHASING control is a differential type, variable air capacitor. It permits adjustment of the crystal selectivity characteristic for high attenuation of closely adjacent channel interference on either side of the signal frequency. PHASING MUST BE AT DIAMOND FOR 3 AND 6 KC SELECTIVITY.

RF Gain Control -- The RF GAIN control varies the overall gain of the receiver. This control is operative in either position of the AVC-MAN switch.

Power Switch -- The power or on-off switch is combined with the RF GAIN control. Complete counter-clockwise rotation of the RF GAIN control throws the power switch to the off position, as indicated on the RF GAIN control dial.

Audio Gain Control -- The AUDIO GAIN control varies the input voltage to the audio amplifier. This control is also operative in either position of the AVC-MAN switch.

Phones Jack -- The PHONES jack is a single circuit jack operating with the sleeve grounded and is suitable to receive any standard single circuit phone plug. It is in the circuit at all times and is connected to a separate secondary winding of the audio output transformer, which provides an attenuated signal for headphones. See Section III installation.

Audio Output -- The AUDIO OUTPUT is available at the four-screw terminal board at the rear of the chassis for connection to a 600-ohm load. See Section III installation.

Noise Limiter -- The LIMITER control switches the noise peak limiter in or out of the circuit. This control is operative independently of any position of any other control. See Section II Circuit Description.

AVC-Manual Switch -- In the AVC position the AVC-MAN switch applies automatic bias potentials to the controlled RF and IF amplifier tubes, thereby holding the audio output relatively constant over a wide variation in the strength of received signals. This minimizes the variation of output due to fading of the received signal and prevents blasting and overloading when tuning through signals of greatly different strength while traversing a frequency band.

In the AVC position the RF Meter circuit is operative for indication of tuning resonance and relative strength of received signals. The RF GAIN control is operative on AVC operation, when necessary to control exceptionally strong signals or to reduce noise, but the RF meter is less effective when the RF GAIN control is below maximum setting. In the MAN position the AVC potential is removed from the controlled tubes and the gain of the receiver is manually controlled by the RF GAIN control.

CW-Modulation Switch -- The CW-MOD control in the CW position energizes the beat frequency oscillator and connects an additional timing capacitor to the AVC circuit to accommodate the AVC to slow keying. In the MOD position the beat frequency oscillator is inoperative and the conditions are established for either voice modulated or tone modulated signal reception.

Beat Frequency Oscillator -- The BEAT OSC control varies the tuning of the 705 kc beat frequency oscillator over a range from zero beat to plus or minus 3 kilocycles.

Send-Receive -- The SEND-REC control is a single pole, single throw toggle switch. In the SEND position it desensitizes the receiver during transmission periods.

Tuning Control and Dials -- The TUNING control rotates the main tuning capacitor as well as the main and vernier tuning dials. The main dial has six frequency band scales, calibrated in kilocycles and an arbitrary outer scale. The vernier dial has an arbitrary 0 to 100 scale. The numeral under the upper or fixed pointer of the main dial indicates the number of complete revolutions that have been made by the vernier dial at any setting. Thus, if the pointer for the outer scale of the main dial indicates over the figure 4 and the vernier dial indicates 87.6, the reading to log for this setting is read 487.6. This precise mechanical vernier system divides the rotation of the main dial over each frequency band into approximately 600 vernier divisions, with one-half division calibration points. Since it is easy to estimate one-tenth divisions on the vernier scale, this divides each frequency band into approximately 6000 readable settings. This permits extreme accuracy in the logging and resetting of stations.

Tuning Lock -- The TUNING LOCK, located to the right of the TUNING control, provides a positive lock for the tuning mechanism without affecting the frequency setting when it is desired to prevent accidental shifting of the tuning.

Band Change -- Each revolution of the BAND CHANGE control turns the turret, containing the RF and HF Oscillator coil, trimmer and switch contact assemblies, from one frequency band to the next. The turret has no stops and may be turned in either direction desired. A positive detent mechanism assures correct location of the various bands. The BAND CHANGE control simultaneously operates the small MEGACYCLES band indicating dial, located at the center of the panel and aligns the dial frequency indicator with the proper scale of the main dial.

Crystal Controlled HF Oscillator -- The XTALS control selects either variable high frequency oscillator operation or any one of the four crystal positions, for which similarly numbered crystal sockets are provided in the Crystal Control Unit. See Section III Installation. The DELTA FREQ control compensates for the small frequency tolerance to which the crystals are made.

Tuning Meter Controls -- The METER ADJ RF control is used to adjust the resistance shunting the meter. It is adjusted to produce a reading of 0 db on the scale of the meter, with a 50 microvolt RF input signal and with the AVC-MAN switch in the AVC position.

Preliminary to Operation -- Turn the power switch "on" by turning the RF GAIN control clockwise and advance this control to 10. Note that the dial lamps light. Place the SEND-REC switch on REC and turn the BAND CHANGE control to the frequency band in which it is desired to operate. This should be done at least 15 minutes before using the receiver, in order to permit the tubes to warm up. Insert the headphones plug in the PHONES jack or use speaker as desired. See Installation, Section III.

MCW Reception -- Turn the TUNING LOCK to its extreme counter-clockwise position and turn the SELECTIVITY switch to 3 kc. Put the CW-MOD switch on MOD, the LIMITER switch to OFF, the AVC-MAN switch on AVC, the XTAL PHASING control at its center position and turn the XTALS switch to VFO. With the BAND CHANGE control in the proper position for the frequency band desired, as indicated by the kilocycles dial, advance the AUDIO GAIN control until some noise is heard. Turn the TUNING control to indicate the desired frequency on the main dial and tune the signal for maximum response or indication on the RF Meter. Readjust the AUDIO GAIN control for the desired output level and as required to prevent overloading. Carefully tighten the TUNING LOCK by turning clockwise, if desired. The SELECTIVITY switch may be turned to the 6 kc position for improved high frequency response if the signal-to-noise ratio is sufficiently high. If the noise level is high, the SELECTIVITY switch should be turned to the bandwidth which provides the most intelligible reception and the LIMITER switch should be thrown "on". The XTAL PHASING control may be adjusted to either side of its center position to attenuate an adjacent interfering signal. The RF GAIN control may be turned down somewhat to reduce noise, during stand-by periods in the transmission, when traversing the tuning range, or during deep fades of the signal. The RF Meter scale calibration is for maximum RF GAIN control operation and indicates only when the AVC-MAN switch is on AVC. When searching for very weak signals the CW-MOD switch may be thrown to CW and the BEAT OSC control set at 0. Locate and tune the signal to obtain zero beat and then throw the CW-MOD switch back to MOD.

The Crystal Frequency Control may be used for fixed frequency operation at any signal frequency for which crystals have been provided. See Section III, Installation. Turn the XTALS switch to the numeral corresponding to that on the panel chart for the desired signal frequency. Set the main tuning dial to the signal frequency and adjust the DELTA C control to obtain zero beat with the CW-MOD switch on CW and the BEAT OSC control at 0. Throw the CW-MOD switch to MOD and adjust the TUNING Control for maximum RF Meter indication or for maximum response.

CW Reception -- The preliminary procedure for CW reception is the same as for MCW reception above. Place the CW-MOD switch on CW and with the BEAT OSC control at 0, tune the desired signal for zero beat. Adjust the BEAT OSC control, in either direction, to obtain the audio pitch desired. The AVC-MAN switch may be used in the position which gives the best reception. Adjust the desired output level by the AUDIO GAIN control when on AVC and by the RF GAIN control when on MAN. The RF Meter does not operate on the MAN position. The SELECTIVITY switch may be used as found desirable, to reduce noise or to provide rejection of an interfering signal. The XTAL PHASING control is adjusted for minimum interference from an adjacent, interfering signal. If interference of this kind persists, further discrimination between the desired and the undesired signals may be realized by slightly detuning the desired signal to the opposite side of resonance from that on which the undesired signal is located and readjusting the XTAL PHASING control and the BEAT OSC control for the desired signal. The Crystal Frequency Control may be used as described under MCW Reception above.



If reception is to be suspended and resumed at short time intervals, the power should be left "on" and for such operation the SEND-REC switch should be thrown to SEND between reception periods. This keeps the receiver warm and ready for instant use.

When operation of the receiver is completed, turn the power "off" by extreme counter-clockwise rotation of the RF GAIN control.

## MAINTENANCE

General -- This receiver is designed for continuous duty and should normally require little attention beyond the replacement of tubes. An occasional cleaning of the gear teeth in the gear train is recommended to prevent a heavy accumulation of dust which may cause calibration error and improper operation of the gears. This may be done with a small stiff bristle brush, turning the controls to obtain access to the different portions of the gears. Operation and maintenance of the receiver will be greatly facilitated if the contents of this instruction book are thoroughly digested. No grease or oil should be used on the gears.

Some sectionalizing of faults is possible, if the fault is not existant on all of the frequency bands.

Visual evidence of trouble is usually a burned or darkened resistor, which, if found, is likely caused by excessive current due to a short circuited capacitor or tube element at the load side of the resistor. In such a case, both the capacitor or tube and the resistor should be replaced as indicated. Refer to Table 5 for values of components. If the checks on tubes, fuses and visual inspection fail to disclose the fault, the tube socket voltages and resistances should be measured and checked against the values given in Tables 1 and 2. Any appreciable departure beyond a normal variation of approximately 15 percent from the values in these tables will generally indicate the component or circuit at fault. If the foregoing does not reveal the fault, then a stage by stage check of amplification should be made as shown in Table 4. Any great difference from the values of input shown in the table will indicate the stage at fault. If a tuned circuit component, such as an IF transformer, RF or HF oscillator coil assembly, is found defective and replaced, only the replaced unit need be realigned. Follow the alignment procedure in Section VI, for the unit involved.

The IF Transformers, Crystal Filter, Beat Frequency Oscillator and the 1160 kc Crystal Controlled Oscillator assemblies are each mounted on the chassis independently of their respective shields. The shield can assemblies are easily removed for inspection of these units, without disturbing the soldered connections. In replacing these shields, make sure that the grounding springs are in place on the inductance adjuster screws before the shield is installed.

Vacuum Tubes -- Weak or defective vacuum tubes are the most common cause of decrease in sensitivity, faulty performance or failure of operation in a receiver. In case of such faults, first remove the tubes and check them in a tube tester of reliable design. If a tube tester is not available, substitution of a new tube for each tube type and position should be tried. See Figures 2 and 3. Such substitution is best made one tube at a time, in order that the faulty tube may be detected by the improvement or restoration of performance by the new tube.

Locating Faults -- If the dial lamps do not light when the power switch is turned on, check for a blown line fuse (F1) and replace it at the rear of the receiver from the spare fuses. An open circuit in the line cord or plug may be checked by plugging a lamp first in the power source receptable and then in the ac receptable on the rear of the receiver. If the dial lamps light but there is no sound at all in the headphones or speaker, check for a blown minus B fuse (F2) and if blown, replace it with a spare fuse. In replacing fuses, make sure that only a 1.6A Fusetron is inserted in the line fuse holder and that only a 3/8 ampere fuse is inserted in the minus B fuse holder. Should neither fuse be blown,

nor replacement of the fuses restore operation, the receiver should be removed from its cabinet or rack and inspected for visual signs of trouble. The table model receiver is held in the cabinet by two screws through the cabinet bottom and by the four screws through the slotted holes at each side of the front panel. The rack model receiver is provided with bottom and top cover plates which should be removed for purposes of inspection and repair.

IF Transformers -- If a fault is traced to one of the variable coupled IF Transformers, T3 or T4, check whether the fault exists on all positions of the selectivity switch S5, or only on one position of this switch. If the faulty operation occurs on only one switch position, check for continuity of the coupling coil associated with that position, check for imperfect soldered connections at the coil and switch terminals and check the switch contact involved. If faulty operation localized at one transformer exists on all positions of the selectivity switch, make the continuity check on the plate coils, on the main grid coil and on the wiring associated with these coils. The transformers T3 and T4, and Crystal Filter T2, have additional inner shield assemblies that are held in place by the tension nuts on the adjusting screws. To remove these shields, hold the adjusting screws with a screw driver to prevent turning the screws and losing the alignment adjustment and loosen the tension nuts, using another small screw driver engaging one of the slots. When replacing these shields and tension nuts, employ the same method and tighten the tension nuts just enough to prevent the adjusting screws from working loose.

Beat Frequency Oscillator -- To remove the beat frequency oscillator T10 if the receiver is equipped with the Crystal Frequency Control Unit Z26, it will be necessary to set the crystal selector switch S2, on its number 3 position and loosen the four set screws in the rigid shaft coupling and the two set screws in the disc on the selector switch shaft. Slide the switch shaft forward through the coupling and disc. It may be necessary to remove burrs, caused by the set screws, from the switch shaft in order to slide the shaft through the disc. Now loosen the four set screws of the flexible coupling on the BFO shafts and slide the coupling forward on the BFO drive shaft in the front panel. Remove the BFO shaft bearing bracket by taking out the two screws holding it to the chassis. Unsolder the leads from the six terminals of the BFO unit at the underside of the chassis, being careful not to overheat the wire of the shielded cable since this wire is insulated with polystyrene and is easily damaged by heat. Note that if this cable wire is grounded to its shield, there will be no beat frequency voltage input to the buffer tube V12 even though the beat oscillator is functioning properly. Therefore, with the shielded lead disconnected from the lug of the BFO unit, check with a continuity or ohmmeter the connection of this wire to capacitor C137 and its freedom from the chassis. Carefully observe the wiring of the BFO unit for correct replacement. Now remove the two screws holding the BFO shield can to the chassis and the two screws at the underside of the chassis and remove the BFO unit. When replacing the unit, follow the reverse procedure. Before tightening the two screws holding the unit to the chassis and the two screws holding the shaft bearing bracket, adjust the unit and shaft bracket to obtain alignment of the two shafts at the coupling. Make sure that the shield grounding spring is in place, with the bow of the spring downward against the tension nut, before replacing the shield can assembly.

Adjustment of BFO -- With the AVC-MAN switch on AVC, and the SELECTIVITY control on the .2 kc position, tune in an unmodulated signal for maximum tuning meter reading. Set the CW-MOD switch to CW and with the BEAT OSC dial at 0, adjust the top screw of the BFO unit for zero beat. Turn the BEAT OSC dial to each 3 kc position and check the output beat frequency against a known audio frequency source such as a good audio oscillator. If the beat frequencies obtained at each 3 kc position is not within the range between 3 and 3.5 kc,

loosen the set screws of the BFO shaft coupling and turn the shaft of the BFO with respect to the drive shaft and repeat the above, resetting the 0 adjustment by the top screws of the BFO unit each time until the above range is realized. One set screw should be used just tightly enough to allow the drive shaft to operate the BFO shaft until the range is correct and then tighten both screws.

Crystal Switch Adjustment -- If the mechanical drive of the crystal control switch has been disturbed, it should be adjusted as follows: Carefully slide the switch shaft through the disc and into the rigid coupling and, being careful not to turn the switch, tighten the four set screws in the rigid coupling, with the knob indicator on the number 3 position as originally set under Beat Frequency Oscillator. Now set the crystal switch on the number 1 position and holding the disc, in a counter-clockwise direction, so that the end of the slot in the disc is against the drive pin, lightly fasten the set screws of the disc. When this disc is properly adjusted on the shaft, with the switch in the number 1 position, the connecting bar between the two discs should not be under tension and should exhibit a slight amount of play when tried with the thumb and forefinger. When so adjusted, tighten the set screws.

Crystal Control Unit -- If it has been determined that the Crystal Control Unit is defective, it will be necessary to remove the unit for repair or replacement. Unsolder the lead of capacitor C88 from switch S3 on the gear plate. Unsolder the black, black-white, blue-red and red-white leads of the crystal control unit from terminal strip underneath the chassis and unsolder the red lead of the unit from filter capacitor C172. Remove the XTALS switch shaft, as described under Beat Frequency Oscillator. Loosen set screws and remove the delta FREQ control knob. Remove the nut and lockwasher at the top of the bracket post adjacent to the power transformer and remove the bracket over the filter chokes. The front end of this bracket is slotted and engages a groove in a mounting post of the crystal control unit. Remove the four screws that secure the filter assembly panel to the mounting posts at each corner of this panel and move the filter assembly sufficiently to permit removal of the four screws holding the crystal control unit to the chassis. When these screws are removed, the unit may be taken from the receiver. In removing the unit and in subsequently handling it, be careful to avoid any strain on the delta FREQ shaft, or the delta C capacitor may be damaged. Remove the four screws holding each of three sides of the cover and spring the two top ends of the cover enough to make the flanges clear the top of the box. Hold these flanges apart to prevent their edges from damaging the parts in the unit while sliding the cover off the crystal unit box. When the unit is to be replaced, follow the reverse of the above procedure. Follow the procedure under Crystal Switch Adjustment to properly reinstall the switch mechanism.

HF Oscillator and RF Coil Assemblies -- If faulty operation occurs in only one frequency band of the receiver, the trouble should be found in one of the four coil assemblies for that band in the tuning unit turret. For example: Coil assemblies Z5, 11, 17 and 23 should be examined if band 100-217 kc only, does not perform normally. To remove these coil assemblies stand the receiver on its right or left side and remove the bottom cover plate from the tuning unit. Turn the band change control to place the band in question in its normal operating position and then turn the band change control two and one-half revolutions counter-clockwise. This will place the band coil assemblies parallel and at the bottom of the tuning unit. Now remove the two springs holding one coil assembly in the turret and carefully remove it by sliding it towards you and off the tongues of the shields. It is best to remove only one coil assembly at a time and inspect it for defects or substitute a replacement assembly if available. Caution: Make sure that the coil base is firmly seated and secured by its retaining springs before going to the next assembly or turning the band change

control. Failure to do this may damage the switch spring contacts beyond repair. Repeat this procedure until the faulty assembly is found. In checking these assemblies, first check for continuity of the coils, particularly the small primary coils as in the RF Input assemblies, where they are liable to damage if the receiver is operated in the presence of very strong transmitter signals. In replacing these coil assemblies be careful that the end of the assembly nearest the coil is toward the front of the receiver.

Mixer Plate Coil Assembly -- Trouble in the Mixer Plate Coil Assembly T1, is indicated if the input required at pin 7 of V5 is found to be greatly different than the values shown in Table 4, and the gain from pin 1 of V7 is normal. To obtain access to the components of the mixer plate coil assemblies it is necessary to remove the crystal control unit and the filter assembly as described under Crystal Control Unit. The cover plate and shield of T1 may then be removed for replacement of a defective component. If the entire assembly is to be replaced, it will be necessary to unsolder all of the leads at both the bottom and top terminal boards of the unit.

RF Tube Platform -- If the receiver fails to perform normally on any of the six frequency bands and the previous tests indicate that performance of the IF and audio frequency amplifiers is normal, including the gain check in accordance with Table 4 for the input to pin 7 of V5, the fault is indicated to be in the RF Tube Platform or in the main tuning capacitor. Before removing the RF Tube Platform, it is advisable to remove the top shield cover and inspect the main tuning capacitor connections. Observe that the tuning capacitor is operating properly when the tuning control is rotated. Using a miniature tube adapter, see Section VI alignment, apply a modulated rf test signal successively to pin 1 of V1 and V2 and to pin 7 of V5. For each of these positions of the adapter and signal, tune through the proper dial setting for the signal frequency used. Gain of the order of 5 or 6 should be indicated for each stage and loss of signal will indicate the section to be investigated for the fault. No signal output, when the input signal is applied to pin 7 of V5, will indicate trouble in the HF oscillator section of the unit. With the covers removed from the tuning capacitor and T1, unsolder the blue, white-black, orange-green, red-white, red-green, yellow-black and blue-red leads that come from the tube platform at the top of T1. Unsolder the leads from the tuning capacitor rotors, stators and ground straps at each section. Unsolder the lead from the tube platform at S3. Turn the Band Change control one-half turn from any band position in order to have the band switch contacts disengaged and leave the band switch in this position until the RF tube platform is replaced, otherwise irreparable damage to the switch contacts will occur. Remove the four screws at the corners of the top of the platform and the four screws at the side flange and carefully remove the platform. In handling be careful to prevent damage to the switch contacts of this assembly. When the unit is ready to be replaced, follow the reverse of the above procedure.

Main Tuning Capacitor -- If it is necessary to replace the main tuning capacitor, the procedure is as follows: Remove the top cover and unsolder the leads of the capacitor as described under RF tube Platform. Bring the capacitor to full mesh by means of the tuning control. Carefully remove the spring and drive link at the front of the capacitor. Remove the single screw that secures the capacitor, frame front plate to the gear plate, looping a piece of small wire around the spacing washer between the capacitor and gear plate. The front capacitor plate is located and held in position by two dowel pins and will not move when the front screw is taken out. Now hold the capacitor by its frame with one hand and remove the rear supporting screw and spacer. The capacitor may now be moved to the rear, to disengage the dowel pins, and lifted from the receiver. Follow the above procedure in reverse when replacing the capacitor.

TUBE SOCKET VOLTAGES - TABLE 1

Voltages to chassis. Measurements made with a Hewlett Packard Model 410B VTVM. Line voltage 117, no signal input. Audio Gain control minimum and CW-MOD switch on CW except V13.

AVC-MAN SWITCH ON "MAN". SEND-REC on "REC"

TUBE	SOCKET PIN NUMBERS									MODE OF OPERATION
	1	2	3	4	5	6	7	8	9	
V1	-1.1	-	6.3AC	4	210	93	-	-	-	RF Gain Maximum
V1	-43	-	6.3AC	-	245	105	-	-	-	RF Gain Minimum
V2	-1.1	-	6.3AC	-	210	93	-	-	-	RF Gain Maximum
V2	-43	-	6.3AC	-	245	105	-	-	-	RF Gain Minimum
V3	0	-	6.3AC	-	275	-	-	-	-	Xtals Sw. on "VFO"
V3	-6.8	-	6.3AC	-	210	115	-	-	-	Sw. on Xtal "1"
V4	130	-	6.3AC	-	130	-90	-	-	-	Xtal. Sw. on "VFO"
V4	-	-	6.3AC	-	-	-5.6	-	-	-	Sw. on Xtal "1"
V5	-12	4	6.3AC	-	145	125	-	-	-	100 Kc Band 5 Xtal Sw. on VFO
V5	-9.2	4	6.3AC	-	145	125	-	-	-	100 Kc Band 5 805 Kc Xtal Sw. on Xtal "1"
V6	-9.5	-	6.3AC	-	215	88	-1.1	-	-	RF Gain Maximum
V6	-9.5	-	6.3AC	-	245	88	-43	-	-	RF Gain Minimum
V7	-1.1	-	6.3AC	-	208	77	-	-	-	RF Gain Maximum
V7	-43	-	6.3AC	-	246	108	-	-	-	RF Gain Minimum
V8	48	-	6.3AC	-	48	-9.5	-	-	-	RF Gain Maximum
V9	-1.1	-	6.3AC	-	195	103	-	-	-	RF Gain Maximum
V9	-43	-	6.3AC	-	245	103	-	-	-	RF Gain Minimum
V10	-1.1	-	6.3AC	-	195	103	-	-	-	RF Gain Maximum
V10	-43	-	6.3AC	-	245	103	-	-	-	RF Gain Minimum
V11	-	-	6.3AC	-	205	133	3.0	-	-	RF Gain Maximum
V11	-	-	6.3AC	-	228	146	3.4	-	-	RF Gain Minimum
V12	-	-	6.3AC	-	195	105	1.4	-	-	RF Gain Maximum
V12	-	-	6.3AC	-	215	108	1.6	-	-	RF Gain Minimum
V13	-25	-	6.3AC	-	63	68	-	-	-	MOD-CW Sw. on "CW"
V13	-	-	6.3AC	-	0	0	0	-	0	MOD-CW Sw. on "MOD"
V14	-	-	6.3AC	-	0	-	-	-	-	Limiter Sw. ON
V15	-	-43	6.3AC	-	8.5	-	-	-	-	RF Gain Minimum
V15	-	-1.1	6.3AC	-	8.5	-	-	-	-	RF Gain Maximum
V16	70	0	2.45	-	-	190	0	5.5	6.3AC	RF Gain Maximum
V17	-	-	270	220	-12	-	6.3AC	-	-	RF Gain Maximum
V17	-	-	280	250	-12	-	6.3AC	-	-	RF Gain Minimum
V18	150	-	-	-	150	-	-	-	-	RF Gain Maximum
V19	-	320	-	-	-	-	-	320	-	Pin 2 to Pin 8 5 VAC
V20	23	-120	6.3AC	-	23	-	-120	-	-	RF Gain Maximum
V21	105	-	-	-	105	-	-	-	-	RF Gain Maximum

TUBE SOCKET TERMINAL RESISTANCE - TABLE 2

Resistance to chassis. Measurements made with Hewlett Packard Model 410B VTVM. Tube removed from socket under measurement. Audio Gain control maximum, RF gain control minimum. Limiter Switch "on". CW-MOD Switch on "CW" - AVC-MAN Switch on "AVC".

SOCKET PIN NUMBERS

TUBE	1	2	3	4	5	6	7	8	9	MODE OF OPERATION
V1	1.7M	0	-	0	21K	18.5K	0	-	-	Send-Rec. Sw. on "REC"
V2	1.7M	0	-	0	21K	18.5K	0	-	-	Send-Rec. Sw. on "REC"
V3	100K	0	-	0	32K	INF.	0	-	-	Xtal Sw. on "VFO"
V3	100K	0	-	0	32K	47K	0	-	-	Xtal Sw. on "Xtal 1"
V4	25K	INF.	-	0	INF.	47K	0	-	-	Xtal Sw. on "VFO"
V4	INF.	INF.	-	0	INF.	47K	0	-	-	Xtal Sw. on "Xtal 1"
V5	50K	680	-	0	26K	30K	560K	-	-	On Band 1 or Band 2
V5	50K	680	-	0	INF.	INF.	560K	-	-	Send-Rec. Sw. on "SEND"
V6	47K	0	-	0	23K	19K	1.3M	-	-	Send-Rec. Sw. on "REC"
V7	1.3M	0	-	0	23K	27K	0	-	-	Send-Rec. Sw. on "REC"
V8	INF.	INF.	-	0	75K	47K	0	-	-	Send-Rec. Sw. on "REC"
V9	1.3M	0	-	0	23K	16.5K	0	-	-	Send-Rec. Sw. on "REC"
V10	1.3M	0	-	0	23K	16.5K	0	-	-	Send-Rec. Sw. on "REC"
V11	100K	0	-	0	22K	53K	270	-	-	Send-Rec. Sw. on "REC"
V12	100K	0	-	0	22K	53K	100	-	-	Send-Rec. Sw. on "REC"
V13	100K	0	-	0	70K	85K	24	-	-	CW-MOD Sw. on "CW"
V14	2M	95K	-	0	0	0	47K	-	-	Limiter Sw. "On"
V14	47K	95K	-	0	0	0	47K	-	-	Limiter Sw. "Off"
V15	0	150K	-	0	1.3K	0	54K	-	-	
V16	125K	500K	1.5K	0	0	25K	4	680	-	Send-Rec. Sw. on "REC"
V17	0	0	20K	20K	77K	-	-	0	-	Send-Rec. Sw. on "REC"
V18	INF.	-	-	-	23K	-	0	-	-	Send-Rec. Sw. on "REC"
V19	-	20K	-	42	-	42	-	20K	-	Send-Rec. Sw. on "REC"
V20	50K	125K	-	0	50K	0	125K	-	-	Send-Rec. Sw. on "REC"
V21	16.3K	-	-	-	INF.	-	0	-	-	Send-Rec. Sw. on "REC"

## VI

### ALIGNMENT

The alignment of a modern communications receiver requires precision instruments and a thorough knowledge of the circuits involved.

Under normal service the receiver will stay in alignment for extremely long periods of time, consequently realignment should not be attempted unless all other possible causes of a particular trouble have been eliminated. When it has been determined that any realignment should be attempted, a great deal of caution should be exercised in making the adjustments, as any required readjustment should not entail more than a slight angular motion of the adjusting screw.

#### ALIGNMENT OF THE IF STAGES

The crystal filters used in T1 and T2 make it necessary to employ the visual method of alignment for the IF amplifier. The required equipment consists of a double image sweep frequency signal generator with frequency adjustable plus and minus from 705 kc, an oscilloscope, a miniature adapter similar to A/N No. CV-49519, and a detector probe. The A/N No. CV-49519 is available as part No. 977 from the Alden Manufacturing Company, 117 North Main Street, Brockton, Massachusetts. A suitable probe consists of a few feet of coaxial shielded cable, a germanium diode such as IN38, two 3 megohm resistors, a 300 mmf capacitor, and a 47 mmf capacitor. One end of the probe cable is connected to the vertical input of the oscilloscope. The other end terminates in a shunt circuit consisting of one 3 megohm resistor, a 300 mmf capacitor and the cathode of the diode. The 3 megohm resistor and the 300 mmf capacitor are connected to the shield. A 3 megohm resistor is connected from the plate to the shield and a 47 mmf capacitor is series-connected from the plate to the probe terminal. First carefully disconnect the cable lead from pin 1 of V7. Connect the sweep generator to this pin through a series .01 mfd capacitor. Temporarily connect a 100K ohm resistor from this pin to the terminal, on the adjacent terminal board to which the white-black wire is connected. Connect the detector probe to either of jumped terminals of the selectivity switch to which the green lead is connected. Remove tube V9 temporarily from its socket; now alternately adjust the plate L30 of T2 with the selectivity switch on sharp and the grid L31 with the selectivity switch on broad, for maximum amplitude and coincidence of pattern. It will be necessary to finely adjust the sweep generator frequency and the crystal phasing control to accomplish coincidence and to establish the sweep generator frequency to agree exactly with the crystal frequency.

Leave the detector probe as connected and reconnect the cable lead normally to pin 1 of V7. Connect the sweep generator to pin 1 of V2 thru a .01 mfd capacitor. Set Band switch for the 217-540 Kc band and the dial to 540 Kc. Now alternately adjust L27 and L28 of T1 for maximum amplitude and near coincidence of pattern. Adjust L29 of T1. There will be some interaction between these adjustments, so it will be necessary to alternately adjust slightly, all three until coincidence is attained on both sharp and broad selectivity switch positions. Now remove the probe and replace tube V9. Connect a shielded lead from the vertical input of the oscilloscope to the diode output terminal at the rear of the chassis. Alternately adjust L32, 33, 35 and 36 in T3 and T4, and C140 in T5 for maximum amplitude and coincidence.

With the AVC-MAN switch on AVC, increase the input from the signal generator to maximum and adjust C157 in T6 for MINIMUM amplitude. Now, with the selectivity switch at sharp .2 kc, CW-MOD switch on "CW", and BFO dial at zero, adjust L42 in T10 for zero beat on the scope. Now reconnect the probe cable to



the vertical input of the scope and connect the probe to the IF output jack J2 with a shunt resistor load of approximately 72 ohms. With the CW-MOD switch on "MOD", adjust alternately L40 and L41 of T11 for maximum amplitude and coincidence, on both 3 and 6 Selectivity. NOTE: SEE "PHASING CONTROL AND MINIMUM HF OSC VOLTAGE", which follows "ALIGNMENT OF THE RF AMPLIFIER AND HF OSCILLATOR".

#### ALIGNMENT OF THE RF AMPLIFIER AND HF OSCILLATOR

To adequately align the RF Amplifier and HF Oscillator, an accurately calibrated signal generator and an output meter are required. The frequencies required are shown in table 3. The location of the adjustments is shown in Figure 3. The use of Table 3 and Figure 3 should be made in following this part of the alignment.

To align the RF input and 1st and 2nd RF stages, disconnect the ground end of the loading resistors on the coil assemblies. Disconnect the blue lead from the terminal of T1 (after removing the cover plate of T1) and temporarily connect a 1 watt 470-ohm resistor from this blue lead to the terminal which has the red-white lead connection. Connect the probe of an RF vacuum tube voltmeter to the junction of the blue lead and resistor. Connect the output of a signal generator to the antenna input terminals thru a series 100-ohm resistor. The low side of the antenna input should be jumped to ground. With signal frequencies as listed in Table No. 3, adjust for maximum voltage on VTVM, being careful to avoid overload by adjusting input or RF gain as required. Reconnect the loading resistors of each band and restore normal connection of the blue lead of T1.

To align the HF Oscillator, temporarily remove the shield can adjacent to the HF Oscillator tube. This can is held by a single screw and is accessible through the hole in the rear of the can. Merely loosen, do not remove this screw. The can is slotted and lifts upward. Accurately checked frequencies should be used, especially for the HF oscillator adjustments since upon this will depend the accuracy of the dial readings. Use sharp .2kc selectivity, unmodulated signals and Beat Frequency Oscillator. Carefully avoid overload by adjustment of signal input and gain controls. Use an insulated alignment tool, preferably with hooded blade at one end for the L adjustments and open blade at opposite end for C adjustments. It will be necessary to alternately align high and low frequencies of a band until no improvement is realized and until the dial reads correctly at both ends of the band.

Following the frequencies, shown in Table 3, align the remaining bands using the same procedure as above.

#### PHASING CONTROL AND MINIMUM HF OSC VOLTAGE

If repairs or realignment have been made, affecting the adjustments of T1 and or T2, it will be necessary to check the NULL adjustment, L29 of T1 and the PHASING control setting of T2 as follows; Connect an RF tube-voltmeter, such as the Hewlett Packard 400C, from pin 1 of V11 to chassis. With no signal input and the receiver dial at 10 kc, the HF oscillator voltage should be of the order of .006 to .01 volts at pin 1 of V11. This voltage should be minimum with the PHASING control at the center or diamond setting. It is also minimized by the NULL adjustment, L29 of T1. If any adjustment of L29 is required to obtain minimum voltage, T1 will have to be readjusted as previously described, alternately with the NULL adjustment for symmetry of scope pattern and minimum voltage at V11. If the PHASING control is off center for minimum voltage at V11, loosen the knob set-screws and reset the dial, with the SELECTIVITY control at 3 kc.

TABLE NO. 3

RF AND HF OSC ALIGNMENT FREQUENCIES AND ADJUSTMENTS

CIRCUIT		HF OSC		ANT		1ST RF		2ND RF	
BAND	DIAL	FREQ	ADJ	FREQ	ADJ	FREQ	ADJ	FREQ	ADJ
10-16	10	10	L	-	-	20.85	L	7.78	L
10-16	16	16	C	12.84	C	-	-	-	-
16-28	16	16	L	-	-	34.50	L	15.10	L
16-28	28	28	C	22.84	C	-	-	-	-
28-50	28	28	L	28	L	31	L	25	L
28-50	50	50	C	50	C	53	C	47	C
50-100	50	50	L	50	L	53	L	47	L
50-100	100	100	C	100	C	103	C	97	C
100-217	100	100	L	100	L	103	L	97	L
100-217	216	216	C	216	C	220	C	213	C
217-540	220	220	L	220	L	220	L	216	L
217-540	540	540	C	540	C	548	C	532	C

TABLE NO. 4

Approximate Signal Input at IF & AF grids for 1 watt output into normal 600-ohm resistive load, RF and AF gain controls at maximum. MAN control Limiter "Off." Input 705kc, 30% modulated with 400 CPS introduced thru a series .01 MFD capacitor.

<u>Input to</u>	<u>Microvolts Input</u>	
	<u>3KC BW</u>	<u>6KC BW</u>
V5, pin 7	110	200
V7, pin 1	175	300
V9, pin 1	835	140
V10, pin 1	5800	2500
V11, pin 1	42000	

With input to V11, Pin 1 for 1 watt output and using dc probe of Hewlett Packard model 410B VTVM the average values of voltages, measure as follows:

<u>TUBE</u>	<u>VOLTS</u>
V 11, pin 5	9.0
V 12, pin 5	5.5
V 14, pin 2	2.8
V 15, pin 2	2.8
V 16, pin 2	.45
V 16, pin 7	1.3
V 17, pin 5	3.7
V 6, pin 5	2.9
V 8, pin 6	7.0

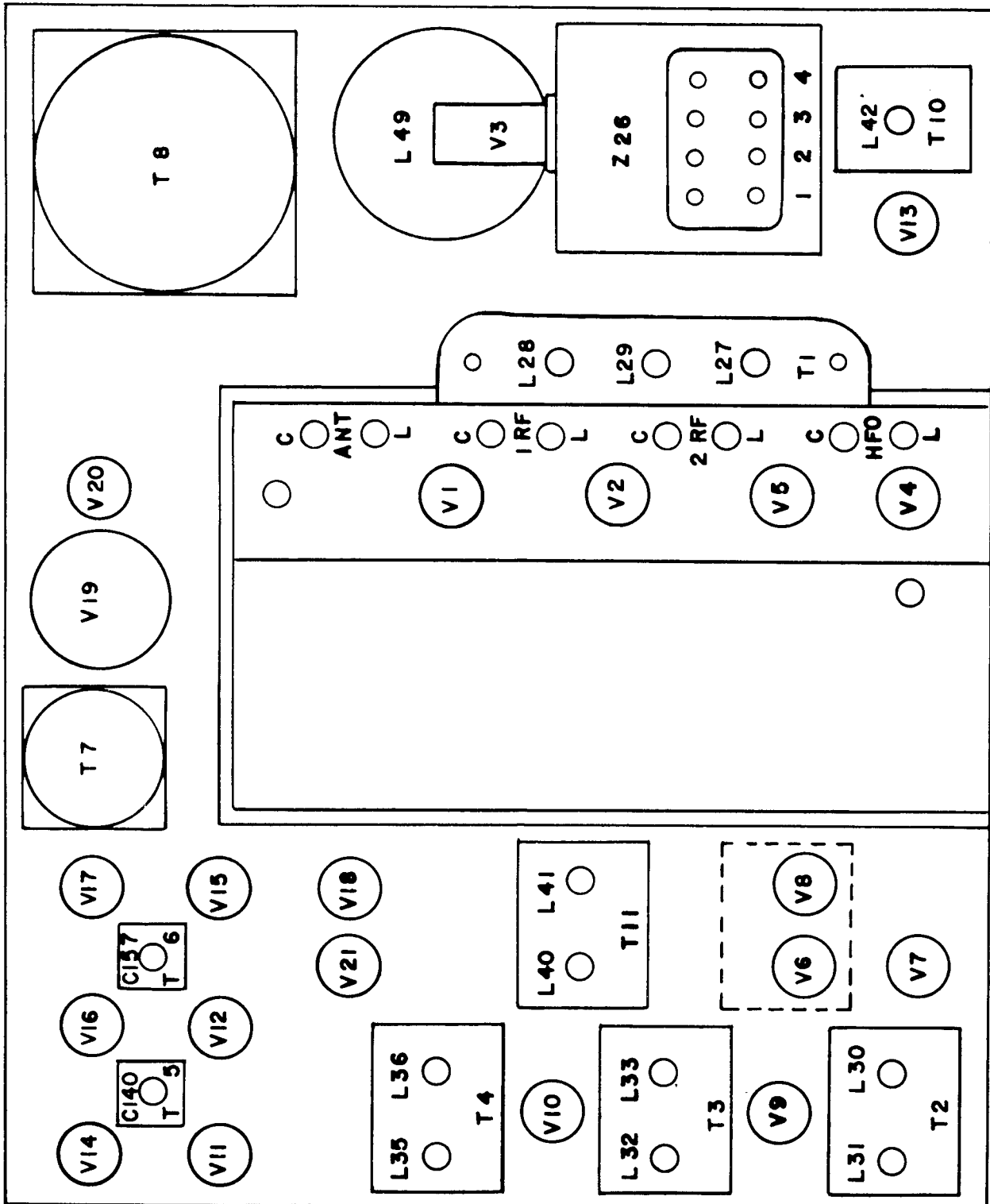

TOP VIEW OF CHASSIS  
 SHOWING ALIGNMENT ADJUSTMENTS  
 FIG. 3

359-6 KEUFFEL & ESSER CO.  
5 x 5 to the 1/2 inch.  
MADE IN U. S. A.

### SELECTIVITY CURVES OVERALL AT 50 KILOCYCLES

FIG. 4

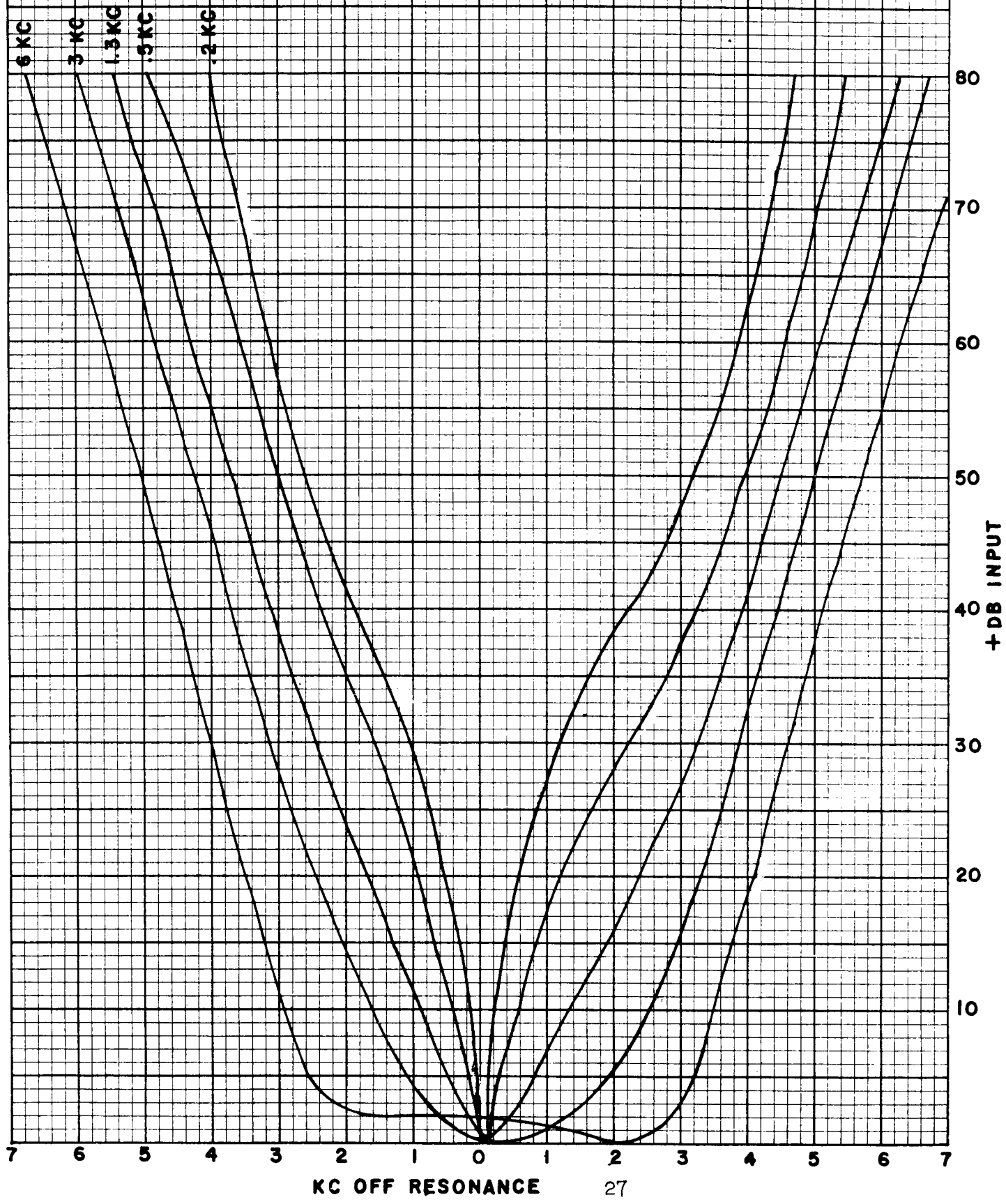

TABLE NO. 5PARTS LIST

<u>SYMBOL DESIGNATIONS</u>	<u>DESCRIPTION</u>	<u>HAMMARLUND PART NO.</u>
C1A To C1H	Capacitor Variable, 8 sections	34001-G3
C 2	Capacitor, .01 mfd	CK63W103Z
C 3	Capacitor, .1 mfd	K-23035-25
C 4 To C 7	Same as C 2	
C 8	Same as C 3	
C 9 to C 11	Same as C 2	
C 12	Capacitor, 1000 mmf	CM20C102J
C 13	Capacitor, 100 mmf	CM15C101G
C 14 - C 15	Same as C 3	
C 16 - C 17	Same as C 12	
C 18	Capacitor, 130 mmf	CM15C131G
C 20	Capacitor, 1300 mmf	CM30E132G
C 21	Capacitor, 10,000 mmf	CM35E103G
C 22 - C 23	Capacitor, 1072 mmf	K-23072-64
C 25	Capacitor, 43 mmf N-750	CC20UJ430F
C 26 - C 27	Capacitor, 48 mmf	K-23071-98
C 28 - C 29	Capacitor, 5 mmf N-750	CC21UJ050C
C 30	Same as C 13	
C 32	Capacitor, 820 mmf	CM20D821G
C 33	Capacitor, 4700 mmf	CM35E472G
C 34 - C 35	Capacitor, 1036 mmf	K-23072-65
C 37	Capacitor, 47 mmf N-750	CC20UJ470F
C 38 - C 39	Capacitor, 93 mmf	K-23071-99
C 40	Capacitor, 75 mmf	CM15C750G
C 42	Capacitor, 91 mmf	CM15C910G
C 44	Capacitor, 51 mmf	CM15C510J
C 46	Capacitor, 454 mmf	K-23071-17
C 47	Capacitor, 27 mmf N-750	CC20UJ270F
C 48	Capacitor, 89 mmf	K-23071-16
C 49	Same as C 47	
C 50	Capacitor, 66 mmf	K-23071-100
C 52	Capacitor, 47 mmf	CM15C470J
C 54	Capacitor, 43 mmf	CM15C430J
C 56	Capacitor, 27 mmf	CM15C270J
C 58	Capacitor, 312 mmf	K-23071-19
C 59	Same as C 47	
C 61	Capacitor, 128 mmf	K-23071-18
C 62	Capacitor, 18 mmf	CM15B180K
C 63	Capacitor, 33 mmf	CM15C330J
C 65	Capacitor, 24 mmf	CM15C240J
C 67	Same as C 62	
C 69	Capacitor, 100 mmf $\pm 1\%$	K-23071-108
C 70	Capacitor, 5 mmf N-750	CC20UJ050C
C 72	Same as C 69	
C 73	Capacitor, 24 mmf N-750	CC20UJ240G
C 74	Same as C 62	
C 75	Capacitor, 10 mmf	CM15B100K
C 79	Capacitor, 15 mmf	CM15B150K
C 81	Capacitor, 103 mmf	K-23071-20

SYMBOL DESIGNATIONSDESCRIPTIONHAMMARLUND PART NO.

C 82	Same as C 70	
C 83	Same as C 2	
C 84	Capacitor, 2200 mmf	CM30E222J
C 85	Capacitor, 39 mmf	CM15C390J
C 86	Same as C 2	
C 87	Capacitor, Variable	11726-G109
C 88	Capacitor, 300 mmf	CM15C301J
C 89 - C 90	Same as C 3	
C 91	Same as C 2	
C 92	Same as C 3	
C 93 - C 94	Same as C 2	
C 95	Same as C 13	
C 96	Capacitor, 7 mmf	CC20CH070C
C 97	Same as C 2	
C 98	Capacitor, 110 mmf	CM15C111G
C 99	Capacitor, 1500 mmf	CM30C152J
C100	Same as C 2	
C101	Capacitor, 51 mmf	CM15C510G
C102	Same as C 65	
C103 - C104	Same as C 2	
C105 - C106	Capacitor, .01 mfd 1400V	23034-26
C107	Capacitor, 240 mmf	CM15C241G
C108	Same as C 2	
C109	Capacitor, 4 mmf	CC20CH040C
C110	Capacitor, 220 mmf	CM15C221G
C111	Same as C 2	
C112	Same as C 98	
C113 - C114	Same as C 2	
C115	Capacitor, Variable	11776-G1
C116 - C117	Capacitor, 68 mmf	CM15C680G
C118	Capacitor, 3 mmf	CC20CH030C
C119	Capacitor, 91 mmf	CM15C910G
C120	Capacitor, 1300 mmf	CM30E132J
C121	Same as C101	
C122	Capacitor, 390 mmf	CM15C391G
C123 - C124	Same as C 2	
C125	Capacitor, 510 mmf	CM15C511G
C126	Same as C 2	
C127	Capacitor, 560 mmf	CM20C561G
C128	Capacitor, 3300 mmf	CM30C332J
C129 - C130	Same as C 2	
C131	Same as C125	
C132	Same as C 2	
C133	Same as C127	
C134	Same as C128	
C135	Same as C 12	
C136	Same as C 2	
C137	Same as C 75	
C138	Same as C 2	
C139	Capacitor, 75 mmf	DM15C750G
C140	Capacitor, Variable	34062-G5
C141	Same as C 2	
C142	Same as C 13	
C143	Capacitor, 1800 mmf	CM30C182J
C144 - C146	Same as C 2	
C147	Same as C 47	

<u>SYMBOL DESIGNATIONS</u>	<u>DESCRIPTION</u>	<u>HAMMARLUND PART NO.</u>
C148	Capacitor, 200 mmf	CM15C201G
C149	Capacitor, 1200 mmf	CM30C122J
C150	Same as C101	
C151 - C152	Same as C 2	
C153	Capacitor, .25 mfd	CP53B1EF254V
C154 - C156	Same as C 2	
C157	Same as C140	
C158	Capacitor, 82 mmf	DM15C820G
C159 - C163	Same as C 2	
C164	Same as C 3	
C165 - C168	Same as C 2	
C169	Capacitor, .005 mfd, 1000V	M23034-10
C171	Same as C 2	
C172 A,B,C	Capacitor, 3 x 20 mfd	CE33F200R
C173 - C175	Capacitor, 10 mfd	CE63C100J
C176 - C181	Same as C 2	
C182 - C183	Same as C 12	
C184	Same as C 2	
DS1 - DS4	Dial Lamp, 150A 6.3V MAZDA 47	16004-1
E1	Terminal Board-Antenna	K-33938-1
E2	Terminal Board-Audio Output	K-31141-1
E3	Terminal Board - AVC-DIODE	K-31480-1
F1	Fusetron, 1.6A (slow-blow)	15893-1
F2	Fuse, 3/8 A	15928-13
J1	Antenna input receptacle UG-103/U	15959-1
J2	IF Output receptacle, S0-239	16111-1
J3	Phone Jack, JK-34-A	5066-1
L25	RF Choke, 2.5 mhy	15627-1
L26	RF Choke, 50 millihenrys	38050-1
L45	RF Choke, 2 ohms dc	15611-1
L46 - L47	RF Choke, 2.7 ohms dc	15613-1
L48	1st Filter Choke, 8.5 hy 170 ohms	31030-2
L49	2nd Filter Choke, 20 hy 440 ohms dc	31031-2
M1	Tuning Meter	16359-1
P1	Power plug and cord	6143-1
P2	Antenna Input Plug UG-102/U	16016-1
P3	Antenna Adapter, UG-104/U	15987-1
P4	Connector Plug for J2, PL-259	16071-1
R1	Resistor, 510K ohm	RC10BF514J
R2	Resistor, 10K ohms	RC20BF103J
R3 - R4	Resistor, 1000 ohms	RC20BF102K
R5	Same as R1	
R6	Same as R2	
R7 - R8	Same as R3	
R9	Resistor, 47K ohms	RC20BF473K
R10 - R13	Same as R3	
R14 - R15	Resistor, 91K ohms	RC20BF913J
R16	Resistor, 1100 ohms	RC20BF112J
R17	Resistor, 9100 ohms	RC20BF912J
R18	Resistor, 4300 ohms	RC20BF432J
R19 - R20	Resistor, 75K	RC20BF753J
R21	Resistor, 1300 ohms	RC20BF132J
R22	Resistor, 11K ohms	RC20BF113J

SYMBOL DESIGNATIONSDESCRIPTIONHAMMARLUND PART NO.

R23	Resistor, 5600 ohms	RC20BF562J
R24	Resistor, 51K ohms	RC20BF513J
R25	Resistor, 120K ohms	RC20BF124J
R26	Resistor, 300K ohms	RC20BF304J
R27	Resistor, 200K ohms	RC20BF204J
R28	Resistor, Same as R25	
R29	Same as R27	
R30	Resistor, 240K ohms	RC20BF244J
R31	Resistor, 100K ohms	RC20BF104K
R32	Resistor, 1.5 meg.	RC20BF155J
R33	Resistor, 510K ohms	RC20BF514J
R34	Resistor, 470K ohms	RC20BF474J
R35	Same as R3	
R36	Same as R31	
R37	Same as R3	
R38	Resistor, 22K ohms	RC20BF223J
R39	Same as R2	
R40	Resistor, 180 ohms	RC20BF181K
R41	Same as R33	
R42	Resistor, 680 ohms	RC20BF681K
R43	Resistor, 6800 ohms	RC20BF682K
R44	Resistor, 2200 ohms	RC20BF222K
R45	Same as R31	
R46	Same as R2	
R47 - R48	Same as R9	
R49	Same as R2	
R50	Same as R3	
R51 - R52	Same as R44	
R53	Same as R2	
R54	Same as R44	
R55	Resistor, 12 ohms	RC20BF120J
R56	Resistor, 82 ohms	RC20BF820J
R57	Resistor, 300 ohms	RC20BF301J
R58	Resistor, 1500 ohms	RC20BF152K
R59	Resistor, 10 ohms	RC20BF100K
R60	Same as R31	
R61	Same as R2	
R62	Same as R44	
R63	Same as R59	
R64	Same as R31	
R65	Same as R2	
R66	Same as R44	
R67	Same as R59	
R68	Same as R31	
R69	Resistor, 270 ohms	RC20BF271K
R70	Resistor, 33K ohms	RC20BF333K
R71	Same as R44	
R72	Same as R9	
R73	Resistor, 1.2 megohm	RC20BF125K
R74	Resistor, 820K ohms	RC20BF824J
R75	Same as R31	
R76	Same as R2	
R77	Same as R9	
R78	Resistor, 4000 ohms 12 W	RW32G402
R79	Same as R31	
R80	Resistor, 62K ohms	RC20BF623J
R81	Same as R9	



SYMBOL DESIGNATIONSDESCRIPTIONHAMMARLUND PART NO.

R82	Same as R3	
R83	Same as R59	
R84	Resistor, 100 ohms	RC20BF101J
R85	Same as R70	
R86	Same as R44	
R87	Same as R2	
R88	Same as R21	
R89	Resistor, 15K ohms 1 watt	RC30BF153J
R90 - R91	Resistor, 27K ohms	RC20BF273K
R92	Resistor, Variable 3500 ohms	RA20A1SA352K
R93 - R94	Same as R44	
R95	Same as R42	
R96	Resistor, Variable 500K, AF gain	K-15342-11
R97	Same as R58	
R98 - R99	Same as R31	
R100	Resistor, 270K ohms	RC20BF274K
R101	Resistor, 1 megohm	RC20BF105K
R102	Same as R9	
R103	Same as R70	
R104	Same as R101	
R105	Resistor, 2500 ohms 12 watt	RW32G252
R106 - R107	Resistor, 82K ohms	RC20BF823J
R108 - R109	Same as R25	
R110	Resistor, 56K ohms	RC20BF563K
R111 - R112	Same as R2	
R113	Resistor, Variable 50K ohm (with S9)	RV4BTRD503E
R114	Same as R16	
R115	Same as R24	
R116	Same as R25	
R117	Same as R31	
R118	Same as R24	
R119	Same as R38	
S1 A,B,C,D	Switch Base and Spring Assembly	31234-1
S2	Crystal Selector Switch	15879-3
S3	Crystal Switch	31469-1
S4,A,B,C,D	Selectivity Switch	38581-1
S5 - S6	Toggle Switch SPST	ST-42A
S7	Toggle Switch DPST	ST-52K
S8	Toggle Switch, DPDT	ST-52N
S9	Switch, "ON-OFF", (Part of R113)	
T1	Mixer Plate, transformer assembly	38598-1
T2	Crystal Filter Assembly	38579-1
T3 - T4	IF Transformer Assembly 705kc	38589-1
T5	Detector Transformer Assembly	38571-1
T6	AVC Transformer Assembly	38571-2
T7	AF Output Transformer	31086-2
T8	Power Transformer	31029-2
T9	IF Output Transformer	38618-1
T10	BFO Assembly	38591-1
T11	IF Transformer Assembly 455 kc	38584-1
X1 - X3	Tube Socket, miniature	TS102P01
X4	Tube Socket, min., ceramic less center shield	15998-5
X5	Tube Socket, miniature, ceramic	TS102C01
X6 - X15	Same as X1	
X16	Tube Socket, Noval	TS103P01

SYMBOL DESIGNATIONSDESCRIPTIONHAMMARLUND PART NO.

X17	Tube Socket, Octal	TS101P01
X18	Same as X1	
X19	Same as X17	
X20 - X21	Same as X1	
X22 - X25	Crystal Socket Millen #33202	38622-1
X26	Crystal Socket for Y7	16092-5
Y1 - Y4	Crystal for Frequency Control (see note *)	38623
Y5 - Y6	Crystal 705Kc	38580-1
Y7	Crystal 1160 kc CR-18/U	38603-1
Z1	RF Input Assy 10-16 Kc	38540
Z2	RF Input Assy 16-28 Kc	38545
Z3	RF Input Assy 28-50 Kc	38549
Z4	RF Input Assy 50-100 Kc	38553
Z5	RF Input Assy 100-217 Kc	38557
Z6	RF Input Assy 217-540 Kc	38561
Z7	1st RF Transf. Assy 10-16 Kc	38541
Z8	1st RF Transf. Assy 16-28 Kc	38546
Z9	1st RF Transf. Assy 28-50 Kc	38550
Z10	1st RF Transf. Assy 50-100 Kc	38554
Z11	1st RF Transf. Assy 100-217 Kc	38558
Z12	1st RF Transf. Assy 217-540 Kc	38562
Z13	2nd RF Transf. Assy 10-16 Kc	38542
Z14	2nd RF Transf. Assy 16-28 Kc	38547
Z15	2nd RF Transf. Assy 28-50 Kc	38551
Z16	2nd RF Transf. Assy 50-100 Kc	38555
Z17	2nd RF Transf. Assy 100-217 Kc	38559
Z18	2nd RF Transf. Assy 217-540 Kc	38563
Z19	HFO Assy 10-16 Kc	38543
Z20	HFO Assy 16-28 Kc	38548
Z21	HFO Assy 28-50 Kc	38552
Z22	HFO Assy 50-100 Kc	38556
Z23	HFO Assy 100-217 Kc	38560
Z24	HFO Assy 217-540 Kc	38564
Z25	FIXED XTAL OSC. Board Assy	31131-G4
Z26	Frequency Control Assembly	31409-G4

## Miscellaneous

Chart, frequency control	31463-2
Dial, band indicator	31201-G4
Dial, Lamp Socket Assembly	31453-2
Dial, main tuning	38605-1
Dial, vernier tuning	31439-1
Fuse Holder	15923-1
Knob and Dial (Audio Gain)	31227-G2
Knob and Dial (Beat Freq. Osc.)	31227-G4
Knob and Dial (Crystal Phasing)	31227-G3
Knob and Dial (RF Gain)	31227-G1
Knob and Dial (Selectivity)	31227-G6
Knob and Skirt (Large)	31215-G1
Knob, frequency control	31434-G1
Knob, tuning lock	31462-G1

SYMBOL DESIGNATIONSDESCRIPTIONHAMMARLUND PART NO.

Miscellaneous	Knurled thumb screw	31495-1
	Shaft Coupling, rigid	31275-G1
	Shaft Coupling, flexible soft	415-G3
	Shaft Coupling, flexible stiff	415-G2
	Snap Button Plug	29619-2
	Spare fuse cover	31494-1
	Spring, anti-backlash	31239-1
	Spring, Band Change Detent	31205-1
	Spring, IF adjuster grounding	31023-1
	Spring, Indicator Slide	31126-1
	Spring, Retainer for RF Coils	31004-1
	Spring, Retainer for RF Coil assemblies	31003-1
	Window, Band Indicator	31282-1
	Window, Tuning Dials	31281-1
	Wrench, Set Screw No. 6	11806-2
	Wrench, Set Screw No. 8	11806-3
	Wrench, Set Screw No. 10	11806-4

## Note \*

Crystals for Crystal Frequency control, supplied on special order, per Hammarlund specification No. 38623. The HF Oscillator Frequency shall be stamped on top of the holder. This HFO frequency is always 705 kc plus the Signal Frequency. Specify Signal and HFO frequency when ordering crystals.

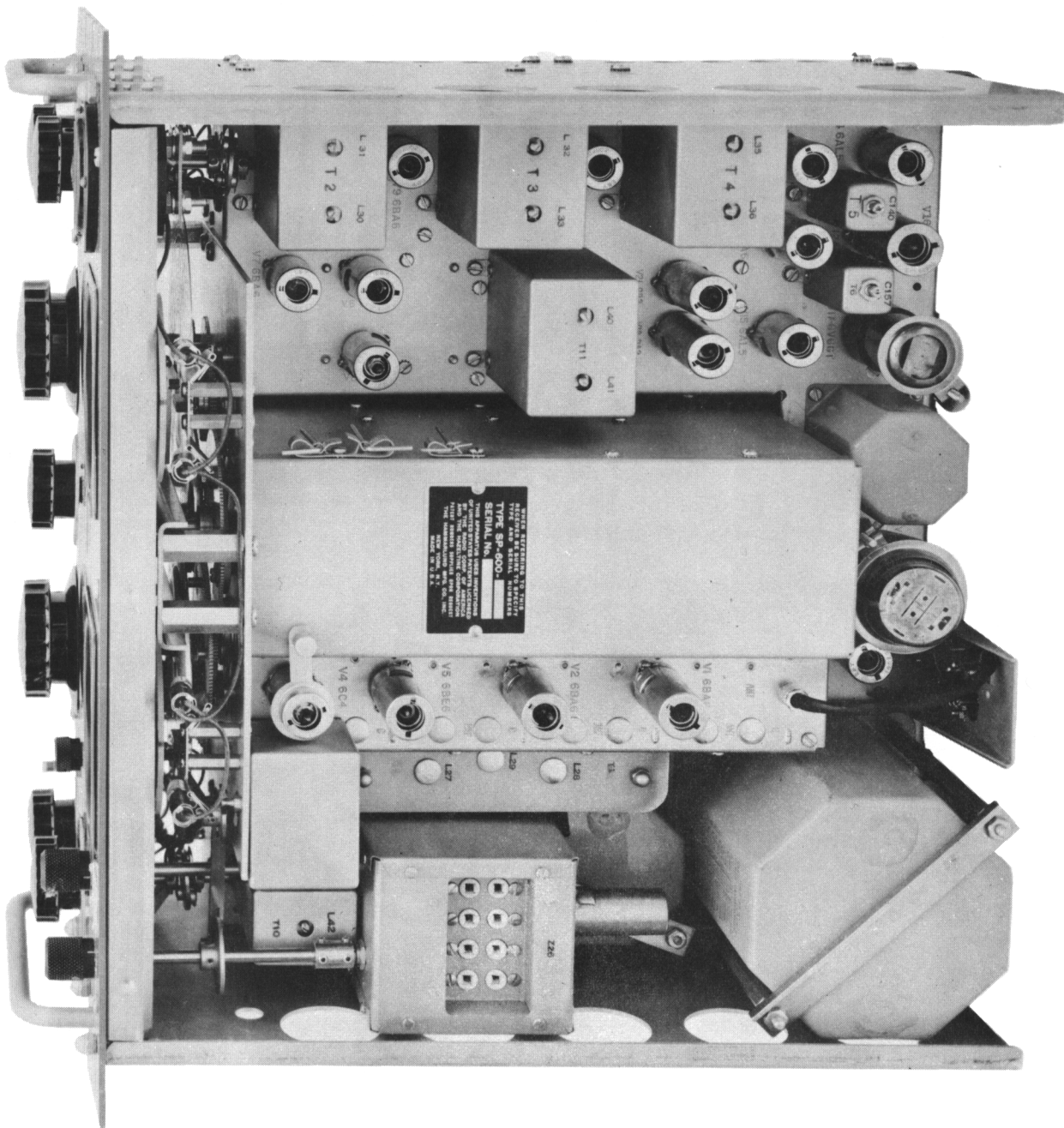

FIG. 5  
REAR VIEW OF RECEIVER

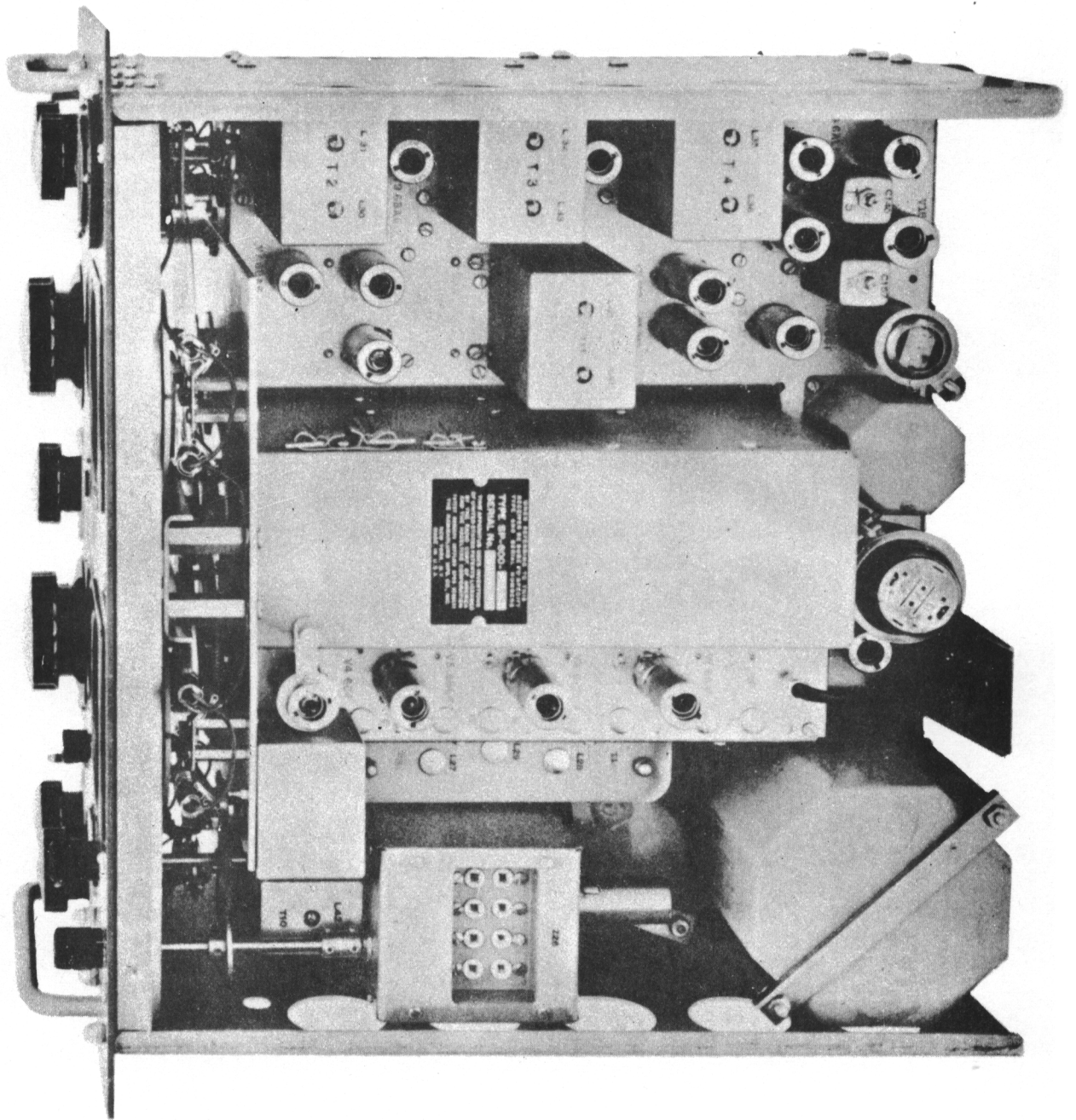

FIG. 6  
TOP VIEW OF RECEIVER

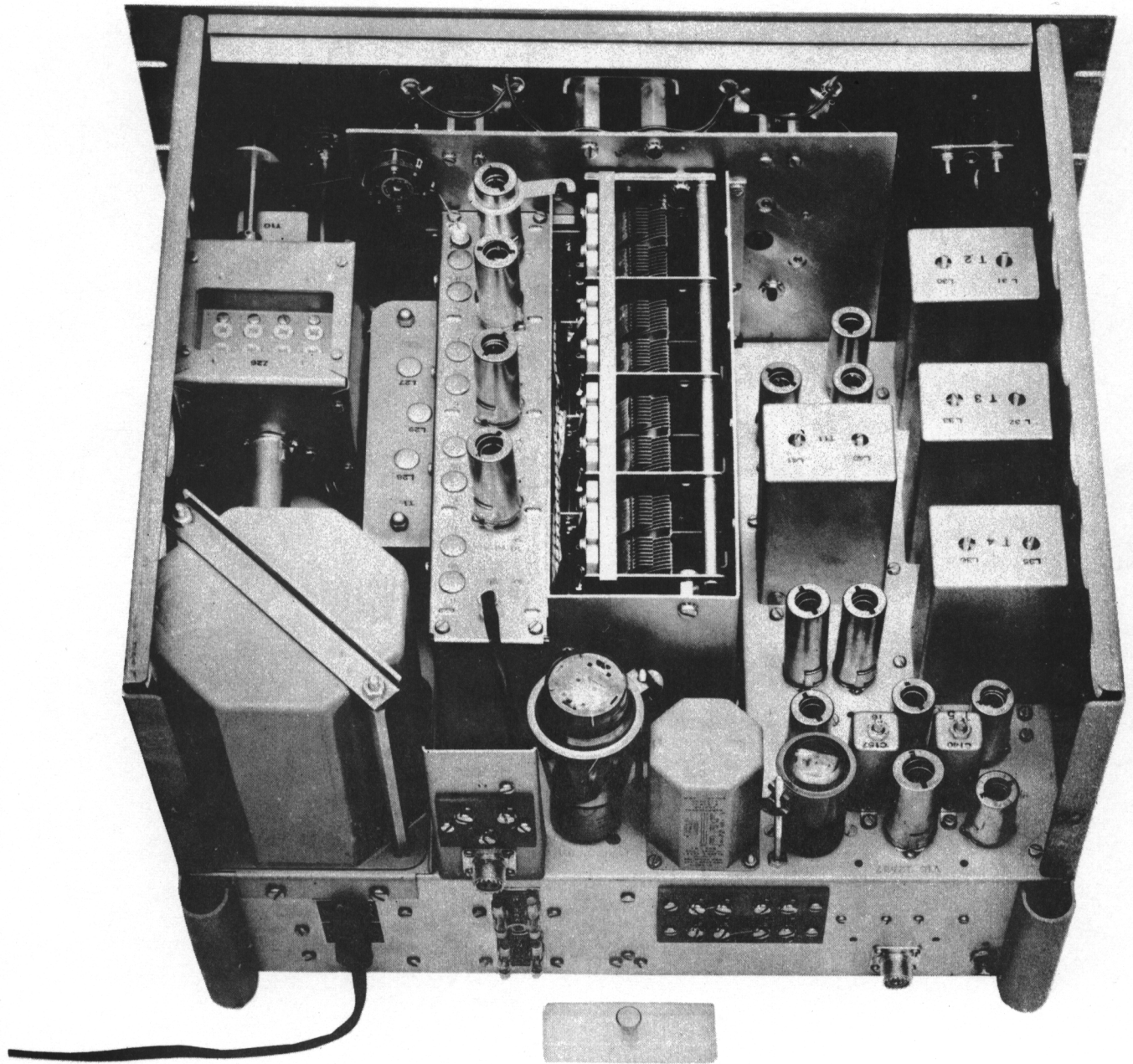

FIG. 7  
TOP VIEW OF RECEIVER  
CAPACITOR SHIELD REMOVED

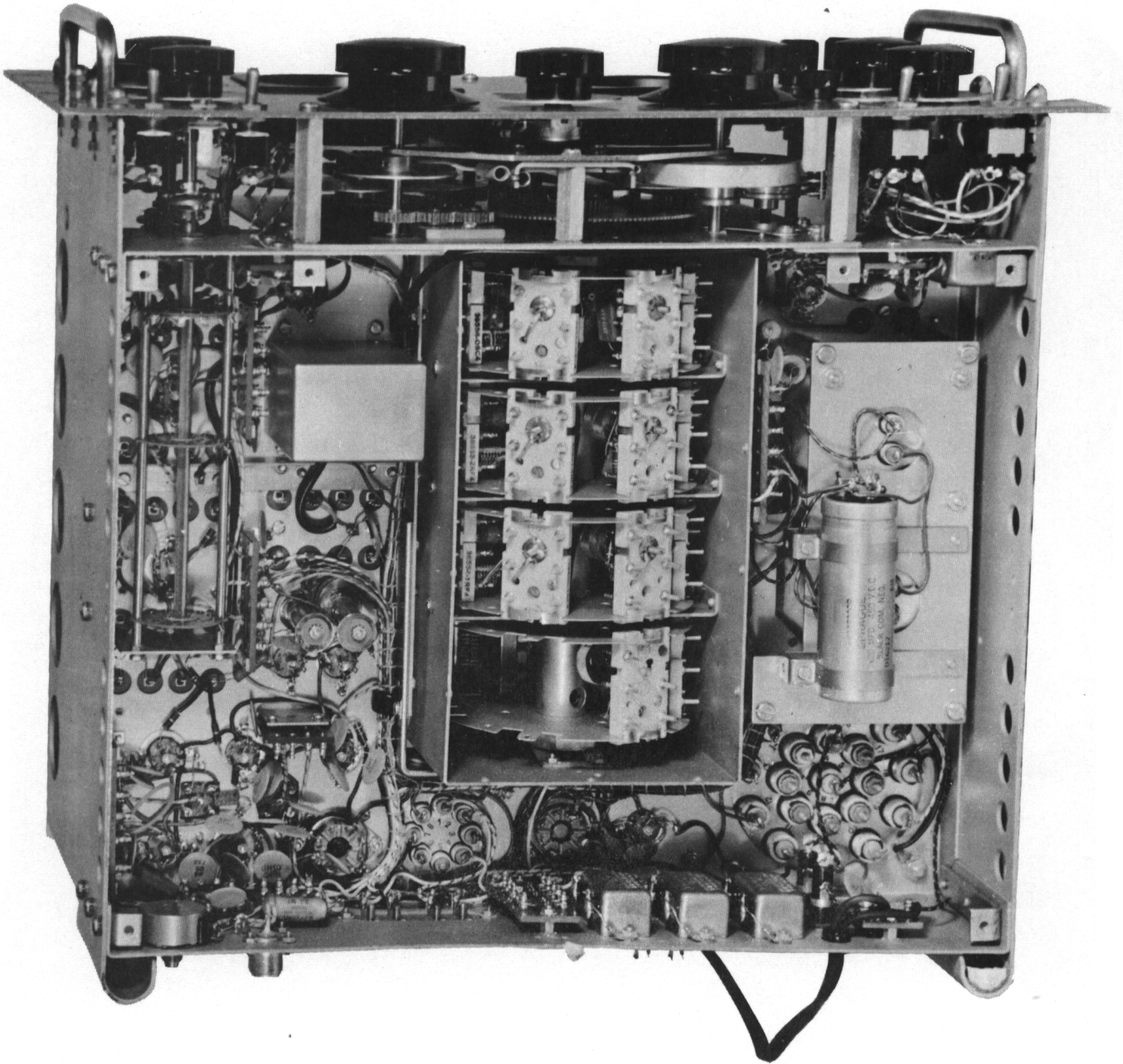

FIG. 8  
BOTTOM VIEW OF RECEIVER  
TUNING UNIT SHIELD REMOVED

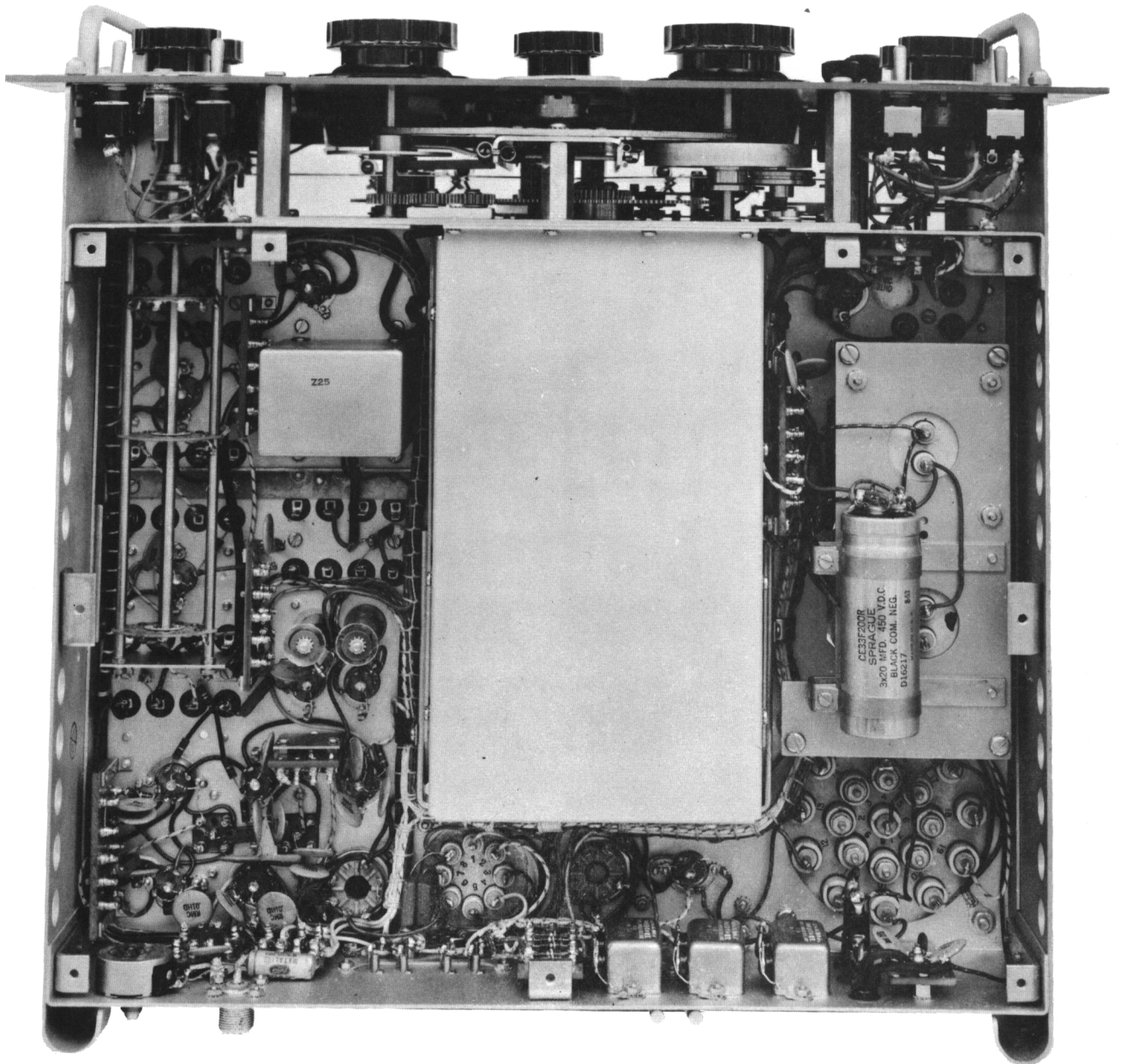
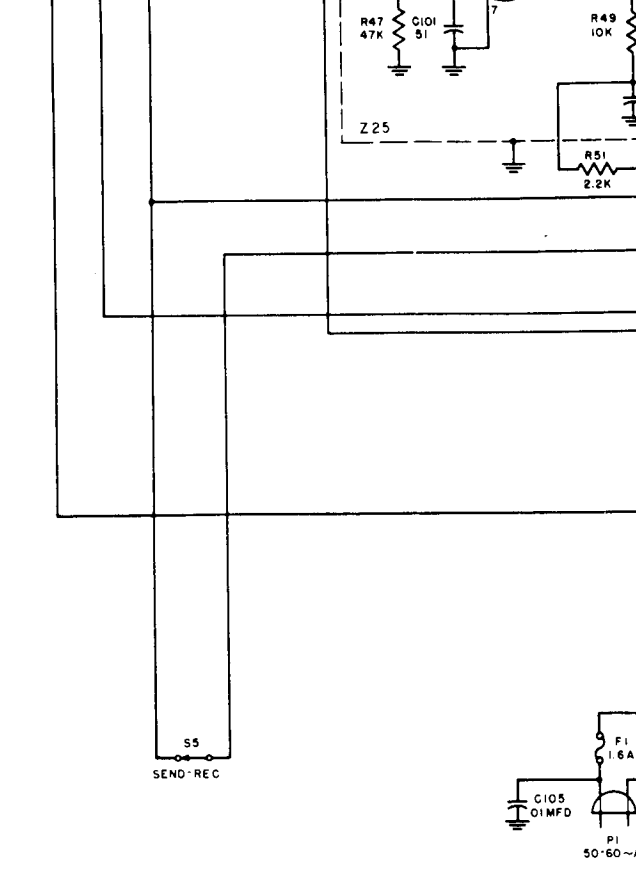
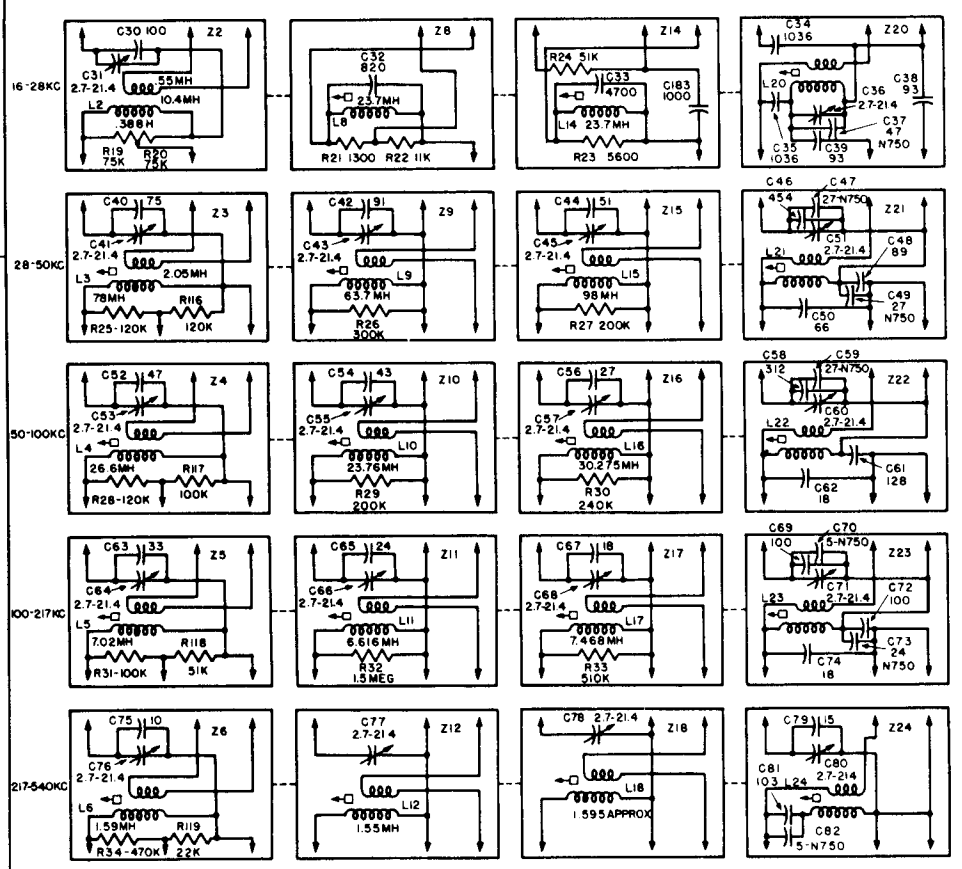
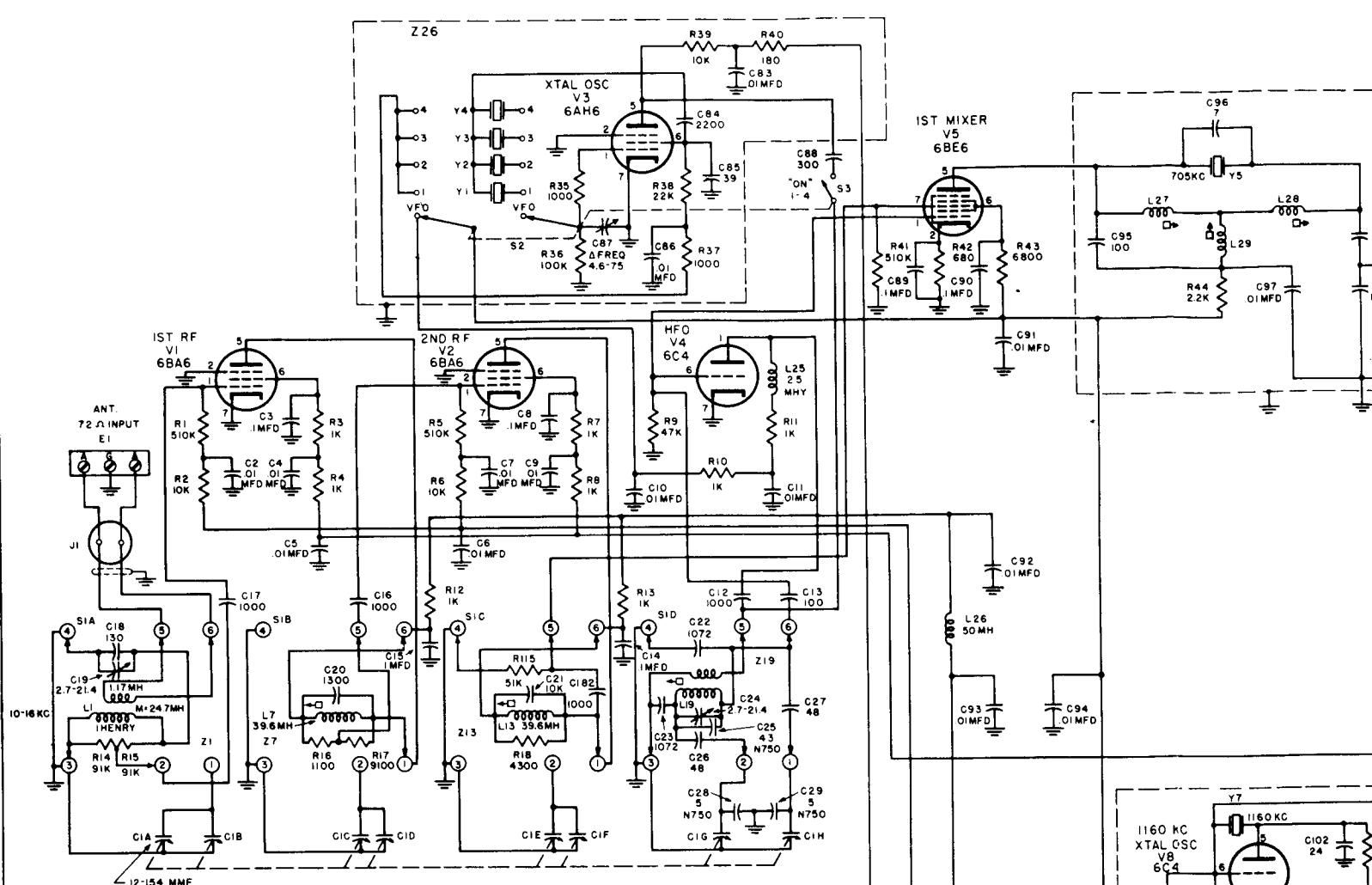
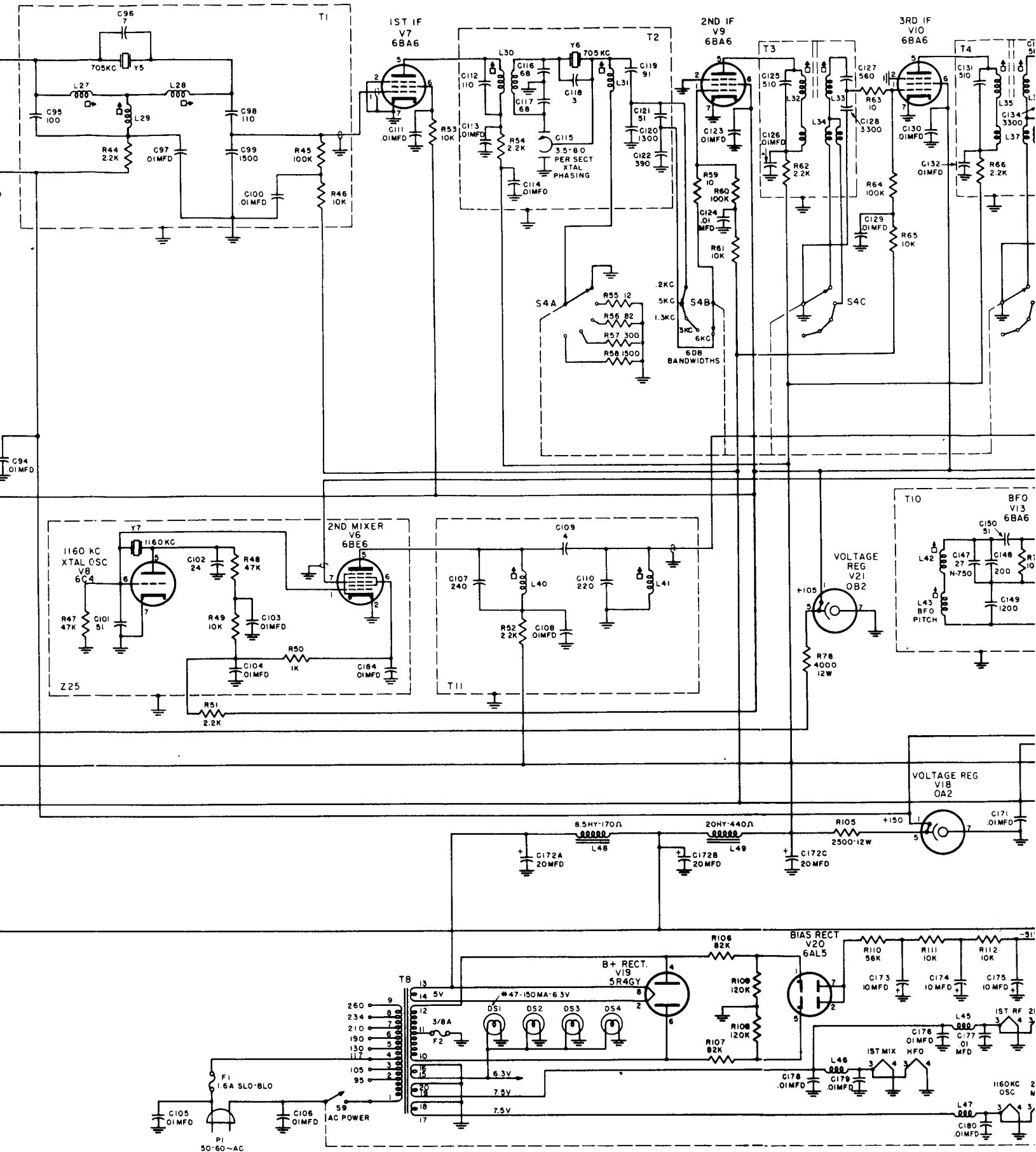

FIG. 9  
BOTTOM VIEW OF RECEIVER







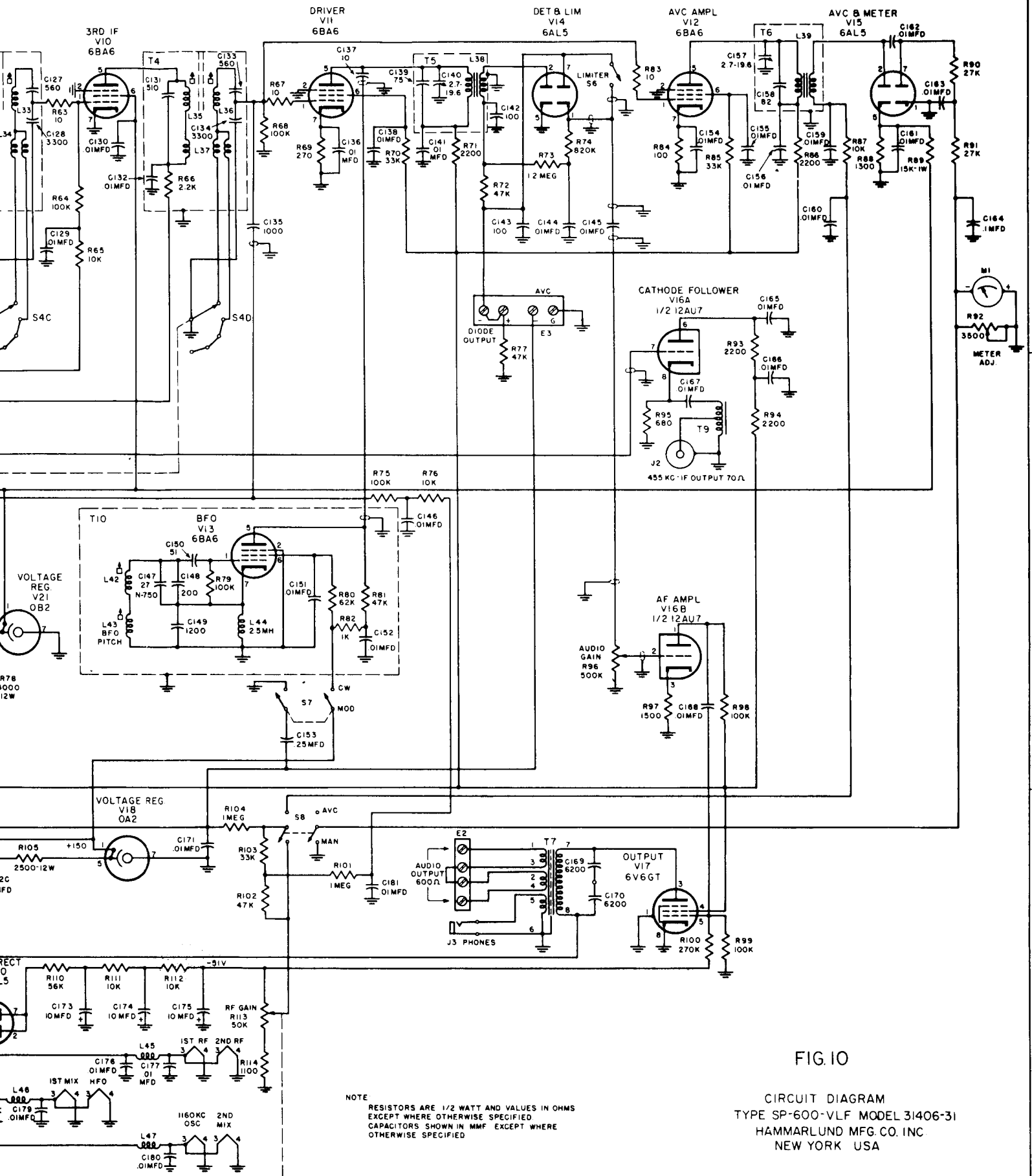

FIG. 10

CIRCUIT DIAGRAM  
 TYPE SP-600-VLF MODEL 31406-31  
 HAMMARLUND MFG. CO. INC  
 NEW YORK USA

NOTE  
 RESISTORS ARE 1/2 WATT AND VALUES IN OHMS  
 EXCEPT WHERE OTHERWISE SPECIFIED  
 CAPACITORS SHOWN IN MMF EXCEPT WHERE  
 OTHERWISE SPECIFIED